

The independent MONTHLY magazine for T/S1000,ZX81 users

48516

Volume 1 #2

U.S. \$2.95  
Canada \$3.95



Bulk rate  
U.S. Postage  
paid  
Permit # 527  
Norwood, MA

# timex sinclair user

Paradoxical  
Clive Sinclair  
Build an EPROM —  
full plans inside!

Kids and  
computers

Enter our  
cash contest  
6 Chess games  
evaluated  
Graphics  
made easy  
**8 pages of  
programs!**



Software, hardware & books reviewed



**YOUR TS1000/ZX81 NEVER HAD IT SO GOOD!**



**ZX81 & T/S 1000 CATALOG**  
SOFTWARE/HARDWARE/BOOKS



**GLADSTONE**

GLADSTONE ELECTRONICS

PHONE ORDERS  
1-800-833-8400  
N.Y. 1-716-874-5510

**Send for your FREE catalog Today!**

NEW from Gladstone Electronics! Our TS1000/ZX81 catalog will take you where no other has gone before! You will view the widest selection of up-to-date software, books and hardware add-ons available to get the most from your personal computer. This exciting new 34 page color catalog lists arcade, fantasy and family games, business and educational programs; books for beginners as well as experienced users; hardware add-ons and other peripherals for use with your TS1000/ZX81 Home Computer! Use the convenient coupon below and send for your FREE catalog TODAY!

**SPECIAL of the month**  
Gladstone  
64K RAM **\$129.95**  
Reg. \$149.95

Clip and mail or circle reader service # 37

**FORM** Mail orders to: Gladstone Electronics Inc.,  
1585 Kenmore Ave., Buffalo, N.Y. 14217

**ORDER** Please RUSH my FREE catalog to me Today!

Name \_\_\_\_\_

Address \_\_\_\_\_

City \_\_\_\_\_ State \_\_\_\_\_ Zip \_\_\_\_\_

**GLADSTONE ELECTRONICS**

1585 Kenmore Ave., Buffalo, N.Y. 14217

Orders only call toll free 1-800-833-8400

For further information (716) 874-5510  
In Canada call toll free 1-800-268-3640  
or (416) 787-1448



# Timex announces a new personal printer. Just for the record.



Now Timex brings you a printer to go with your Timex Sinclair 1000™ or Sinclair ZX81.

The new Timex Sinclair 2040.

32 columns wide. Two lines per second. With full graphics and text capability based on a dot matrix print mechanism.

The price: just \$99.95.

The TS 2040 operates silently in two different modes:

- Full-screen printing with single-key copy command.
- Program-controlled printing mode allowing for custom control of the printing format.

A printer that can give you a permanent record of your computer programming at a very affordable price.

Just what you'd expect from Timex.

**TIMEX COMPUTERS**



# Contents

## timex sinclair user

**President**  
Terry Cartwright

**Editor-in-chief**  
John Sterlicchi

**Managing Editor**  
Joseph Gladstone

**Art director**  
Vladyana Kryorka

**Production editor**  
Bill Gladstone

**Art assistants**  
Andres Hannach  
Don Kletke  
Gwen Egan

**Technical advisors**  
Robert Fraser  
Igor Nowikow  
Tom Perrone

**Editorial assistant**  
Becky Ashwell

**Chairman**  
Richard Hease

**Timex Sinclair User is published monthly by ECC Publications Inc. in conjunction with C.W. Communications/Inc.**

If you would like to contribute to Timex Sinclair User, please send programs, articles or ideas for hardware projects to:  
Timex Sinclair User  
49 LaSalle Avenue  
Buffalo, N.Y. 14214  
Programs should be on cassette and articles should be typed. If you wish your material returned, enclose a stamped, self-addressed envelope.  
We pay \$20 for each program published and \$100 per 1000 words for each article used.

© Copyright 1983  
Timex Sinclair User  
ISSN 0737-0881  
Typesetting by  
International Typesetting  
Printers  
Clark Franklin Kingston Press  
**Advertising manager**  
Bill York  
Hajar Associates  
(617) 444-3946



Clive turns computers to cash, page 66



Education myths exploded, page 22

<b>TIMEX EXPECTATIONS</b> _____	<b>3</b>
Why doesn't Timex provide more after-sale support?	
<b>LETTERS</b> _____	<b>6</b>
"The T/S1000 is more than a toy"	
<b>SOFTWARE</b> _____	<b>7</b>
Space and adventure games and an assembler program reviewed	
<b>HARDWARE</b> _____	<b>12</b>
In search of a golden memory	
<b>NEWS</b> _____	<b>14</b>
T/S1000 and ZX81 combined sales over 1.6 million; Clive Sinclair awarded; and more	
<b>SPECIAL OFFER</b> _____	<b>15</b>
Save 30% from the price of The 1983 Sinclair User Annual	
<b>COVER: THE GREAT CONNECTICUT KIT-BUILDING EXPERIMENT</b> _____	<b>16</b>
Teacher Chris Baldwin helped 28 kids build computers from kits	
<b>EDUCATION</b> _____	<b>22</b>
Charles Durang explodes some old myths about computers in the classroom	
<b>FOCUS: CHESS SOFTWARE</b> _____	<b>28</b>
Check our guide to chess programs before you make a move	
<b>HOW TO PROGRAM</b> _____	<b>30</b>
Part two of John Gilbert's five-part series	
<b>PROGRAM PRINTOUT</b> _____	<b>33</b>
Bowling, Alien Lure, Laser Cannon and other great new games	
<b>HINTS &amp; TIPS</b> _____	<b>42</b>
Michael K. Barnett explains how to start using T/S graphics	
<b>PROJECT: EPROM BLOWER</b> _____	<b>46</b>
Complete plans to build your own Erasable, Programmable ROM	
<b>USER GROUPS</b> _____	<b>56</b>
Is your group included in our national listing?	
<b>STARTING OUT</b> _____	<b>61</b>
What to do once your T/S1000, ZX81 is home from the store	
<b>U.K. WINDOW</b> _____	<b>63</b>
Sinclair users in Britain eagerly await two new expansion systems	
<b>PROFILE: CLIVE SINCLAIR</b> _____	<b>66</b>
A glimpse of the man who made computers accessible to nearly everyone	
<b>BOOKS</b> _____	<b>68</b>
A kids' book that will delight beginners of all ages; all about ROMs; and more	
<b>CONTEST</b> _____	<b>70</b>
Win \$20 for a clever, different, strange or unusual program	
<b>BULLETIN BOARD</b> _____	<b>71</b>
New product information and upcoming events	

## Next month

- Inside a T/S1000 computer camp!
- Sneak preview of the T/S2000!
- and much more!



T/S1000,ZX81 users  
wait in vain for important support  
services

## Timex needs higher profile

**W**ELCOME to our second issue. Your response to our first was overwhelming and really gratifying. From all of us on this side of *Timex Sinclair User* to all of you, "Thanks".

Our contest editor is screaming for more help to deal with all the great games that are pouring in. In case this is your first look at us, last month we started the first in our series of contests. It required that you write a "great" action game, but use only 2K of memory. The winners will receive a contract to have their programs published and



sold nationally. Then they can rake in all those lovely royalty checks. The contest doesn't officially close until June 10, so if you haven't entered yet, it's still not too late. For details of our latest contest, flip to page 70. This one, we're sure, will challenge your imagination and skill.

Still on the subject of your input, the eight pages of Program Printouts that appear in every issue are also supplied by you the readers. For any that we use, we pay \$20. We look for interesting and different programs. Programs that we feel will be enjoyed by the readers that use them. You'll see one of the programs this month is by an eleven-year-old and another by a fifteen-year-old. And finally on your letters to us, may I remind you that we like to share your ideas, hints and problems. So many readers asked about graphics on the T/S1000,ZX81, that our Hints and Tips column this month is devoted entirely to that aspect of programming.

*Timex Sinclair User* was at the West Coast Faire in San Francisco (see the news item on page 14). While it was a great fair, we were stunned by the fact that Timex had absolutely no presence there at all: not a hospitality suite, not a booth, not a table, not even a speaker! It is our opinion that at a personal computer show which attracted 50,000 spectators (each willing to pay \$15) the company that has sold more personal computers than any other in North America has a need . . . no, an obligation to be there. An obligation to support all those who chose the Timex Sinclair computer as their personal choice. It would not have had to be a large, elaborate affair, but it certainly

would have made us feel better if we could have had an identification point with Timex there.

It is important that Timex provide owners with visible support, if for no other reason than to show they consider those owners important. There is a feeling in the market place that Timex Sinclair computers are not serious machines; that they are toys; that they are not capable of doing interesting and involved work. T/S,ZX owners know this is not true. Anyone who has used the machine for a while realizes this is not true. It would not only help build a better image for the machine if Timex were at personal computer shows, but it would also make those people who own one now feel like they belong to a personal computer fraternity.

Any person who buys a T/S1000 is a potential purchaser of a larger machine. The Japanese have been threatening to flood the \$100, \$200 and \$300 price ranges with a whole set of new machines. If we can judge by how the Japanese have entered markets in the past, then we can expect these new imports to arrive with great fanfare and much TV hooplah! They are sure to be serious competitors to Timex Sinclair. What better way for Timex to insure its place in the market than to maintain a high profile with current owners and keep potential owners thinking T/S? User loyalty can only



be developed when users feel that both individually and as a group they are seen to be important to Timex.

It makes good sense (and dollars) for both now and the future that Timex become involved through fairs, shows and user groups with owners. Each owner is a potential second buyer, either of a Timex Sinclair machine or another make. Each owner is a salesperson for Timex Sinclair, either positively or negatively. Each owner has spent money with Timex Sinclair and deserves after-sale support.

Timex has a good reputation! The T/S1000 is a good machine! We're certain that the next computers from Timex will be equally as good. *Timex Sinclair User* wants to support Timex Sinclair computers. So, come on Timex, help us say great things about you!







# Increase Your Computer's Utility With Our Help

**Y**ou own a powerful computer, capable of sorting, analyzing, calculating, displaying and manipulating data as well as measuring and controlling. Despite its small size, your computer will help you learn, analyze your business, keep your records or your schedule, dial your phone, send messages, or talk to other computers. To control the power available to you, you'll need hardware and software to use with your machine. Although you can buy many of these products—and we'll tell you about them—some you must create or modify for yourself. SQ will provide you with the complete information to let you use your programming or tinkering time efficiently.

Our experts also bring you SYNTAX, the newsletter, for up-to-date, concise information. You need news and new product announcements quickly. And SYNTAX packs a lot of information into its brief, time-saving format.

But we recognized your need for material too long to fit in SYNTAX. Syntax Quarterly fulfills that special need. In-depth, extensive, detailed information—that's what SQ's all about. Long programs, big construction articles, and detailed directions help you use your computer to its fullest while learning.

SQ gives you tested, accurate information that you can depend on. We test, we build, we check everything that goes into SQ. Our staff experts work for you; it's as though your full-time staff prepared a report for you every quarter.

At SQ, we specialize in your machine—Timex-Sinclair technology. Our programs and projects work, and, because we test each one before we publish it, they work on your machine. All the information in SQ can work for you.

But, to capture these benefits—free software, free plans for hardware, free instruction—you must subscribe. Use the coupon to tell us how to help you best. Or call; we understand people in a hurry.

**SQ**

```

100 LET A$="┌"
200 LET B$="└"
250 LET C$="┐"
300 PRINT A$,A$
400 PRINT B$,B$
500 PRINT B$( TO 7),B$
600 PRINT B$( TO 7),B$
700 PRINT A$,B$
800 PRINT " ";B$(2 TO ),B$
900 PRINT " ";B$(2 TO ),B$
1000 PRINT B$,B$
1100 PRINT A$,A$
1200 PRINT AT 7,22;C$
1300 PRINT AT 9,24;C$
1400 FOR I=0 TO 248
1450 IF I>66 AND I<128 THEN GOTO
1500 PRINT CHR$ I;
1600 NEXT I
1700 PRINT AT 10,0;" WE SPEAK Y
OUR LANGUAGE
SYNTACTIC SUM: 22174, 8K ROM
    
```

```

WE SPEAK YOUR LANGUAGE 0123
456789ABCDEFGHIJKLMNPOQRSTUVWXYZ
RNDINKEY$PI
"AT TAB ?CODE VAL LEN
SIN COS TAN ASN ACS ATN LN EXP
INT SQR SGN ABS PEEK USR STR$ CH
R$ NOT ** OR AND <=>=<> THEN TO
STEP LPRINT LLIST STOP SLOW FAST
NEW SCROLL CONT DIM REM FOR GOT
O GOSUB INPUT LOAD LIST LET PAUS
E NEXT POKE PRINT PLOT RUN SAVE
    
```

For more information, circle 2 on Reader Service Card.

**617/456-3661**

**617/456-3661**



# Letters

## LENDING AN EAR

I purchased the Timex Sinclair to see if a 60-year-old retired gent could learn computer programming. I do have problems finding books that do more than teach one to input programs and play games. I have purchased five books on the T/S1000 and ZX81 and have yet to find an adequate explanation of PEEK and POKE. Most of the computer magazines cater to "far out" programming ... very little is published in the form of a course to take the beginner through.

Thanks for listening.

**Fred Kujawa**

You are in luck, Fred. Starting in our premier issue (May 1983), we are presenting a course in programming written by John Gilbert. Take a PEEK at it, POKE around it, and before you know it, you'll be using those functions with the best of them.

## KEEPING THE FAITH

I would like to say that it's about time someone believed the T/S1000 is more than a toy — I am personally sold on it. After I've made all the additions to it (keyboard, 64K RAM pack, printer, etc.) I'd be willing to bet the T/S1000 will match any of those others!

I worked on an Apple in programming school, but bought the T/S1000 because I can bring it up to that level for less dollars. I am really happy with it.

I just wanted to thank you for having faith in the Timex Sinclair computers, because I sure do!

**David Brehm**

We agree, David, and so do over a million other computer enthusiasts. Let us know what new ideas you come up with for your machine.

## COMPLAINT DEPARTMENT

I am an owner of a T/S1000 but it doesn't work. I asked Sinclair for some information on how to fix it and all I got was a bunch of nothing.

Thank you.

**Roger Odan**

Roger, you are saying what a great number of people have said (see our interview with Dan Ross, May, 1983). We have sent your letter on to Timex. Let us know what happens.

☞☞

Timex Sinclair User welcomes reader's comments, compliments, queries and complaints. Letters should be addressed to: The Editor, Timex Sinclair User, 49 La Salle Avenue, Buffalo, N.Y. 14214. Please include your full name and address when writing.

## INNO VATION "WHERE IDEAS COME TO LIFE"

16529 LAKESHORE ROAD CLEVELAND, WISCONSIN 53015 PH. (414) 693-8062

### EXCLUSIVE TACTILE KEYBOARD OVERLAY

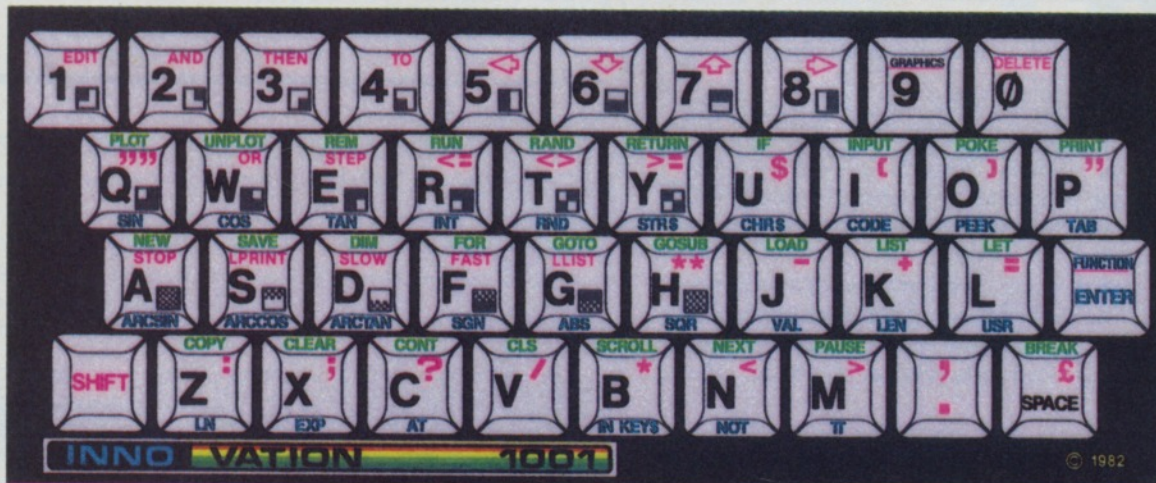

- RAISED DEPRESSABLE KEY AREAS - FEEL MOVEMENT **\$9.95**
- STANDARD TYPEWRITER KEY SIZE
- EASY CUSTOMER ATTACHMENT - OVERLAYS PRESENT KEYBOARD OF THE TIMEX 1000 AND SINCLAIR ZX-81 HOME COMPUTERS

**CONSULT YOUR LOCAL RETAIL STORE**

For further information or mail order via M.C. or Visa direct inquiry to InnovationCo.Dept. U



This month we review space and adventure games and an assembler that lets you program in machine language

## Push-button Star Wars

### Shoot Your Way To Safety

**Description:** **Combat Flight** casts you as the commander of a fighter ship, flying through mountainous terrain shooting at alien ships. Seven types of alien ships fly by. Points scored depend on the type of alien you hit with your lasers. A player gets three lives per game.

After the game, the top five scores are displayed with the name of the player. If you score in the top five you add your name to the list.

**Evaluation:** This is a good action game. The speed of lasers is fast and the response time of the controls is good. It is an

easy game to play with only three keys to press — Q for up, A for down and ENTER for firing.

The graphics in **Combat Flight** show a passing mountain range. The player must avoid hitting the

good quality with good graphics and fast action. This games pack is a good buy for those limited to 2K of memory. (Circle 41 on reader service card.)

Rating: 7

### Aliens Attack

**Description:** In **Galactic Invaders**, seven alien crafts fly randomly around the screen, and fire at your laser base. The base can withstand seven hits before it is destroyed. After all seven crafts are destroyed, seven more appear and move at a higher speed. The player scores one point for each craft shot down.

**Evaluation:** Although this may sound like a standard

mountains, flying too high and running into alien ships. This is challenging because the alien ships often fly close together.

**Combat Flight** is a good game but it is very similar to many other games on the

space invader game, its speed makes this a good game. The player is given an initial choice of speeds from 1 to 100. When I played, speed 1 was too slow and 100 was too fast. At speed 50, I destroyed 53 enemy crafts.

One annoying feature of this game is that the alien crafts often land on the ground for long periods of time. When this happened, I felt obliged to ram the craft with my laser base.

**Galactic Invader** works in 16K and is distributed by Sams. It is a simple, fast action game that can be enjoyed by all ages. Definitely a must for the video game connoisseur. (Circle 42 on reader service card.)

Rating: 8

market. I found the game a little too repetitive in its action and would not want to play it often. Distributor: Melbourne House Ltd. Memory: 16K.

Rating: 7.

### Fast Action In 2K

**Description:** In **TS Destroyer**, you fly in the center of the screen, and objects fly toward you from the left; you must dodge or shoot them. At the same time, another spaceship is flying up and down to your right, taking shots at you.

In **Space Raid**, you control a gun that moves horizontally across the bottom of the screen. When a spaceship appears at the top of the screen with an alien inside, you must shoot a hole through the spaceship and hit the alien in the left foot before a laser beam from the ship hits you.

**Evaluation:** I was very surprised by the high quality of these two games. Programmed in machine language, they have the speed and excitement found in larger 16K games.

The speed of movement in **TS Destroyer** is very impressive. Playing this game, I was so busy trying to dodge objects from the left that I failed to see the ship at the right shoot me in the back.

The **Space Raid** game is very similar to **Invasion Force**. The computer graphic of the alien standing in the spaceship is well

### 2K games will please

**Description:** **Starblaster** is one of six 2K games on a tape sold by Softsync Inc. The game uses machine language to scroll stars right to left across the screen. The player scores points by moving a base in front of the stars.

**Evaluation:** The major problem with **Starblaster** is the instructions. The information with the games gives the wrong controls for movement. Also, the instructions do not clearly tell the player how to score points.

The other five games of this package are all of a



# NOW. A TS1000/ZX81 PUSH-BUTTON KEYBOARD FOR UNDER \$20.00.

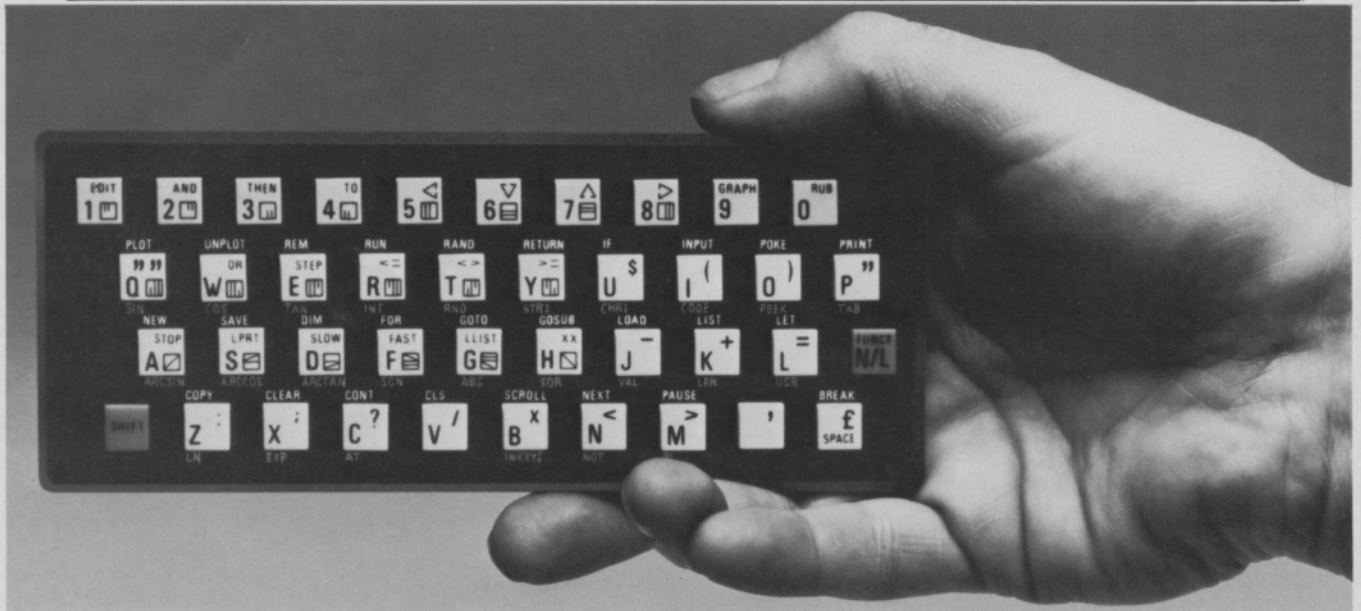

At last there's a really cheap but efficient way of ironing out the TS1000/ZX81's only real bug: its keyboard. The Filesixty Buttonset offers

- A full-travel calculator-type moving keyboard for only \$19.50.
- Installed in seconds. The peel off adhesive backing means you just register into position and press.
- No messy labels, dismantling or soldering.
- 3 groups of colour keys to pick out shift, numerals and newline.
- Precision moulded in ABS to match your TS1000/ZX81, with contrasting legends for maximum legibility.

Orders to Filesixty Ltd., 25 Chippenham Mews, London W9 2AN, England. Tel: 01-289 3059. Telex: 268 048 EXTLDN G 4087.



1. Make sure the original keyboard is clean and check that all the keys function.

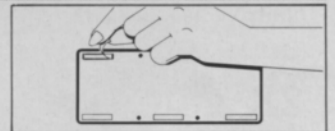

3. So all you do is remove the protective backing.

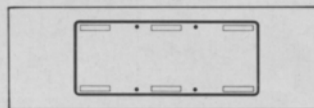

2. The Buttonset is held in place by self adhesive pads.

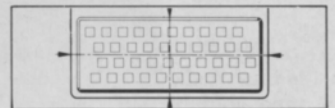

4. And place it centrally on your TS1000/ZX81.

Cheques/money orders made payable to Filesixty Ltd.

Please send me \_\_\_\_\_ (qty.) Buttonset(s) at \$19.50 each (inclusive of postage & packaging).

Total \$ \_\_\_\_\_ BLOCK CAPITALS

Name \_\_\_\_\_

Address \_\_\_\_\_

State \_\_\_\_\_

Zip \_\_\_\_\_

**FILESIXTY**

USA2TSU

For more information, circle 3 on Reader Service Card.



done. The descending laser beam from the ship is challenging to avoid.

Neither of these games prints a score. Usually I like to see a score after I've been shot, but in these games, it didn't matter. For 2K game players, this tape is a must. The distributor is Softsync. (Circle 43 on reader service card.)

Rating: 9

## ★★★★★★ A-maze-ing 3-D overview

**Description:** **Labyrinth** is a game sold by Mindware that creates a maze which the player must go through. At the start of the game, the player must choose the width and height of the maze. Before entering the maze, the player is given the option of seeing it first. This gives the player plenty of time to plan a route through the maze.

The player is shown an image representing his view of the maze showing doorways and corridors in three dimensions. Movement through the maze is done by four direction keys. At any point, the player can give up and see a full view of the maze. The computer will show the path that was taken by the player.

**Evaluation:** **Labyrinth** is an interesting game because the player sees such a small portion of the maze. The three-dimensional graphics showing the passageways are adequately handled with the T/S1000, ZX81 graphics. The game is quite difficult the first couple of times. With practice, however, the passageways are easier to recognize and movement through the maze is much simpler. This is an interesting game but not a classic! (Circle 44 on reader service card.)

Rating: 7.

## More Missile Madness

**Description:** A missile launcher moves up and down on the left side of the screen in the program called **Missile Launcher**. You fire missiles at ammunition dumps on the right side of

the screen. The player gets 25 shots and scores points for hitting the ammunition. Bonus points are scored for destroying an entire ammunition dump.

**Evaluation:** Shooting at targets is a popular concept in games but, to be most effective, any such game requires an opposition that

shoots back. **Missile Launcher**, programmed entirely in Basic, is too simple and slow.

The player controls only the firing of missiles. This requires the player to judge when the row of the missile launcher equals the row of an ammunition dump. This 16K game, distributed by Intercomputer, did not hold the interest of this reviewer for very long, so I played it only a couple of times. (Circle 46 on reader service card.)

Rating: 5

## ★★★★★★ Defend your planet

**Description:** You are in charge of a missile launcher and must save Earth from invading spaceships. With 15 rockets, you must choose a velocity to shoot down the invaders. The direction of each rocket is determined by the velocity you choose for it.

If that sounds like an exciting game, then you would probably like **Galactic Invasion**, sold by International Computers Ltd. This is one in a set of six 16K programs on one tape. Also on the tape are three action games, a solitaire game and a drawing program.

**Evaluation:** This form of **Galactic Invasion** is very simple in graphics and design. The alien invaders are represented by 35 plotted points, and a message at the top tells you how many spaceships are left. This game may be adequate for children but most adults will find it slow.

The five programs with **Galactic Invasion** are also slow and simple. This tape is not recommended to those who like action. (Circle 47 on reader service card.)

Rating: 5



**Description:** Machine language programming is very slow and tedious without using an assembler program. International Publishing and Software sells **ZX Assembler**, a program that allows you to enter and edit machine language using mnemonics.

**ZX Assembler** occupies 7K and is located at the top of memory. It stores the machine language in a REM statement at the start of the Basic program and the assembly language in a second REM statement. An easy-to-follow 26-page manual comes with the program, describing its use in detail.

Editing functions allow you to insert and delete characters and lines. Numbers can be entered in decimal or hexadecimal. Mnemonics can be entered very quickly because the input response time is fast.

The program also contains a monitor which has many useful functions. From the monitor, one can run a machine code routine for testing, inspect and modify registers, search for numbers, and display the HEX contents of memory.

**Evaluation:** Its high speed makes machine language very attractive to serious programmers. Execution speed of instructions is far superior to Basic instructions. Programming in machine language is much more difficult than Basic but programs such as **ZX Assembler** offer the programmer valuable aid.

Without an assembler, programmers must POKE into memory the decimal code for each instruction. Editing in this manner becomes very difficult. **ZX Assembler** contains all the functions necessary for easy machine language programming.

The major drawback with **ZX Assembler** is its location in memory. It uses 7K of memory, limiting the size of the basic program. Because it is not relocatable, its position limits programmers with greater memory to 16K.

**ZX Assembler** is a very useful tool for beginners or professionals. A beginner with a good book on Z80 machine language will find this program easy to use. (Circle 45 on reader service card.)

Rating: 8



# NOW YOU CAN HAVE ALL THE ANSWERS

With the most complete Sinclair software library available.

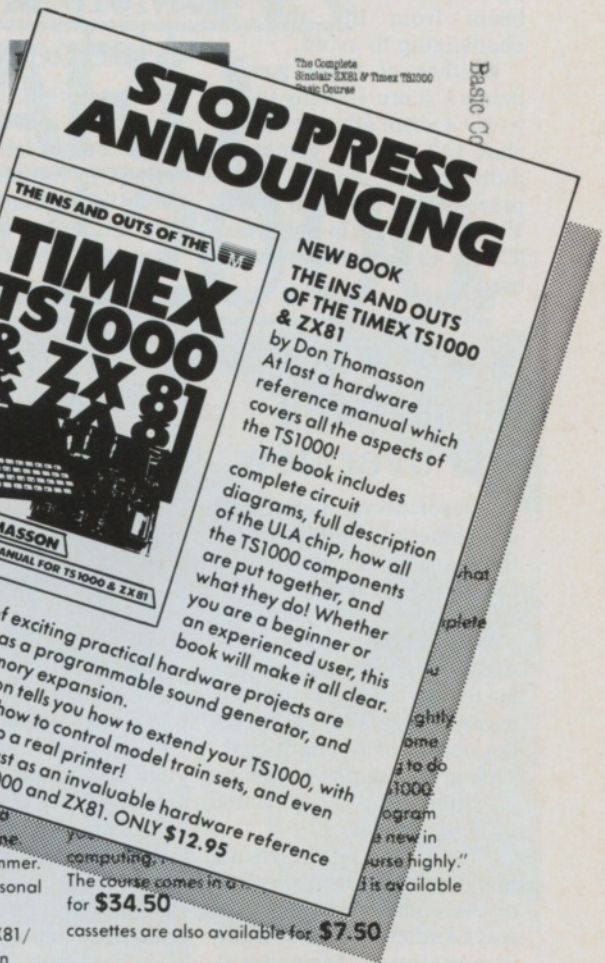
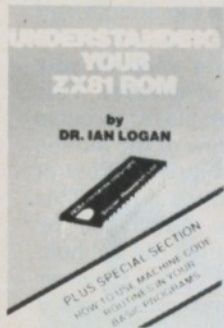

## UNDERSTANDING YOUR ZX81 ROM

by Dr. Ian Logan  
 SYNC Magazine said: "SYNC readers will recognize Dr. Logan as a major ZX80/81 expert whose writings are well worthwhile. *Understanding Your ZX81 ROM* is no exception. The book falls logically into five parts: a brief review of the Z80 CPU, next a quick introduction to the internal arithmetic and number base manipulations; a discussion of the Z80 machine code instructions grouped by function; a detailed examination of the relevant parts of the 8K ROM; Dr. Logan introduces machine code programming by treating it as an extension to Basic; and complete listings of the more important 8K ROM routines are given as well as the usual tables of machine code language instructions, decimal-hexadecimal conversions, and keycodes. *Understanding Your ZX81 ROM* should be high on your list." Now available for only **\$14.95**

## MACHINE LANGUAGE PROGRAMMING MADE SIMPLE

Michael Roberts, *SYNTAX* Magazine wrote: "I wanted to review this book because I'm the person it was written for. I taught myself BASIC and can now do most of the things I want to with it. I felt that Machine Language would be a good addition to speed up some programs and improve display. The idea of Machine Language 'made simple' appealed to me. It's the best explanation of Machine Language for Machine Language beginners I've seen.

Its friendly style is painless reading and analogies help make this language. This introduction is a must." Now available for only **\$14.95**

## NOT ONLY 30 PROGRAMS

is a collection of programs for the ZX81/TS1000. Not only Battles Blackjack, Wall Breaker, Mini 1K Draughts, but also each program includes programming hints, space PEEK and POKE explained. *ZX Computing* said "This book can be crammed into Sinclair. Now available for only **\$14.95**

## THE COMPLETE TIMEX ZX81 ROM Disassembly

(Includes Dr. Logan and Dr. Frank O'Hara have examined all routines in the ROM and comment on each one. This book is a must for the experienced programmer. *L'Ordinateur Individuel* (the leading French personal computing magazine) said: "Dr. Ian Logan has disassembled the 8K monitor program of the ZX81/TS1000. For those who want to write programs in machine language, it is PART A which is the more interesting, because it contains the majority of BASIC commands, while Part B is far more technical, comprising essentially of the ZX81/TS1000's floating point calculator. In conjunction with *Understanding Your ZX81 ROM* this book allows anyone well

## STOP PRESS ANNOUNCING



### NEW BOOK THE INS AND OUTS OF THE TIMEX TS1000 & ZX81

By Don Thomasson  
 At last a hardware reference manual which covers all the aspects of the TS1000!

The book includes complete circuit diagrams, full description of the ULA chip, how all the TS1000 components are put together, and what they do! Whether you are a beginner or an experienced user, this book will make it all clear.

A number of exciting practical hardware projects are included, such as a programmable sound generator, ROM/RAM memory expansion. Don Thomasson tells you how to extend your TS1000, with full details, from how to control model train sets, and even how to connect it to a real printer!

This book is a must as an invaluable hardware reference manual for the TS1000 and ZX81. **ONLY \$12.95**

**Plus award winning software!**

Orders to: **MELBOURNE HOUSE SOFTWARE INC.**  
 Dept. CS 347 Reedwood Drive, Nashville, TN 37217

Visa and M/C orders can be phoned in: 615/361-3738

Dealer orders and queries: 800/251-5900 (ask for a Melbourne House operator)

- TAPES:**
- 13941 Gamestape 1: 11 Programs - 1K \$14.95
  - 13942 Gamestape 2: 3 Games - 16K \$14.95
  - 13943 Gamestape 3: Catacombs Adventure - 16K \$14.95
  - 13944 Gamestape 4: 3D Monster Maze - 16K \$14.95
  - 13945 Gamestape 5: 3D Orbiter - 16K \$14.95
  - 26446 Space Trek - 16K \$14.95
  - 26359 Super Invasion - 1K \$14.95
  - 26318 Wall Busters - 1K \$14.95
  - 26472 10 Exciting Programs - 1K \$14.95
  - 26284 Reversi - 1K \$14.95
  - 26406 Toolbox - 1K \$14.95
  - 26490 Basic Course 2 cassette pack \$7.50
  - 14026 Combat Flight - 16K \$14.95

- BOOKS:**
- 25895 The Complete Basic Course \$34.50
  - 25957 Machine Language Programming Made Simple \$14.95
  - 20922 The Complete Timex/Sinclair ROM Disassembly \$19.95
  - 26025 Not Only 30 Programs \$9.95
  - 25913 Understanding Your ZX81 ROM \$14.95
  - 51539 Ins and Outs of the Timex TS1000 \$12.95

TOTAL: \$ \_\_\_\_\_

Residents of CA, MD, TN, please add sales taxes: \_\_\_\_\_

Add \$2 for Shipping & Handling, foreign orders add \$6: \_\_\_\_\_

TSU6 TOTAL: \$ \_\_\_\_\_

Enclosed is my check or money order for \$ \_\_\_\_\_

Please charge my  Visa or  MasterCard Card # \_\_\_\_\_ expiration date \_\_\_\_\_

Signature \_\_\_\_\_ Name \_\_\_\_\_

Address \_\_\_\_\_ City \_\_\_\_\_ State \_\_\_\_\_ Zip \_\_\_\_\_

# MELBOURNE HOUSE SOFTWARE



For more information, circle 4 on Reader Service Card.



**YOU  
CAN MAKE  
A FORTUNE  
IN MICROS!**

## THE MICRO COMPUTER BUSINESS WILL GROW FROM \$10 TO \$100 BILLION IN THE NEXT EIGHT YEARS! ARE YOU READY TO CASH IN?

The micro computer business is predicted to grow from its present \$10 billion to \$100 billion before 1990! Imagine the possibilities this opens for you! No matter where you live, if you're starting up or presently in business, **no other industry offers you more opportunities!**

Now, finally, all the inside information you need to secure a prosperous future in this dynamic industry is available in **one place - THE COMPUTER ENTREPRENEUR MANUAL!** - An immense information source, compiled by our inquisitive research team, aided by a panel of experts and business people from all areas of the computer industry!

We present the inside story of more than 100 lucrative computer businesses you can enter, where you'll find the real opportunities for the eighties: from one man operations like Programming Author, Word Processing Center or Consulting, to Systems House, Service Bureau, Computer Store etc! Many at little or no investment! All the invaluable facts and figures: How to start, Capital needs, Profit estimates and Margins, How to Sell and Market, How missing technical or business experience need not stand in your way, Source of Suppliers, etc! Details that could take years to find out on your own!

We'll show you inside tricks, like how to never again pay retail for computer products and consumer electronics, even for one item - right now, while you're starting your business! How to get free merchandise and trade show invitations, etc. This alone will more than pay for the manual! You'll read actual case histories of other computer entrepreneurs, so you can learn from their mistakes, and profit from their success stories! Where you'll be one year from now depends on your actions today! Let us show you how to take the first crucial steps!

Order now and take advantage of our limited introduction special, THE COMPUTER ENTREPRENEUR MANUAL, and a six month subscription to THE COMPUTER ENTREPRENEUR REPORT/NEWSLETTER ( so you're always up-to-date with the industry ), both for only \$29.95! You must be convinced on how easy you can strike it rich in the micro computer business - or you may return the manual for a full refund within thirty days! USE OUR TOLL FREE NUMBER TO ORDER!

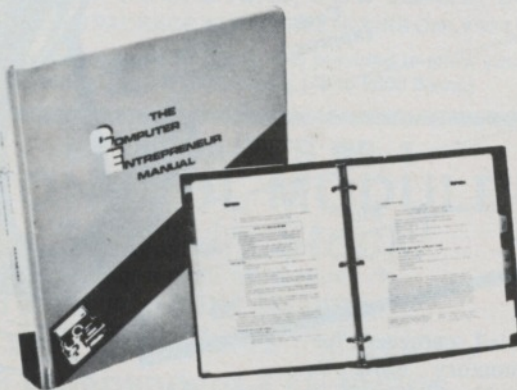

### EVERYTHING YOU NEED TO KNOW TO SUCCEED IN THE COMPUTER BUSINESS IS ALL IN THIS MANUAL!

THE COMPUTER ENTREPRENEUR MANUAL has the answers to all your questions about selecting, starting and successfully running a computer business! There has never been such a comprehensive collection of know-how and information about this business in one place! All the facts you need to plan and achieve your goals in easy-to-follow, step-by-step instructions!

These are some of the 100-plus businesses covered in PART ONE of the manual, with the facts on How to start and run, Start-up Cost ( Even how to operate on a shoestring ), What profits to expect, Wholesale prices, Mark-ups, Suppliers, future outlook, case histories for each, etc:

Systems House, Software Author ( who to sell to and who to avoid ), Service Bureau, Software Publisher ( How to find programs that sell, Word Processing Service, Consulting and Consultant Broker ( use your skills or those of others, make \$150 - \$1000 a day! ), The incredible Games Business, Computer Store ( Franchises: Pro and Contra, or a low inventory store in your home! ), OEM, Hardware Mfg, Data base and Teletext Service ( big prospects! ), Used Computers, Repairs, Rent-A-Computer, Promote Fests and Trade Shows, Turnkey Systems,

Bartering, Mail Order, Compile and rent mailing lists, Specialized Data Headhunting and Temp Help Service, Tech Writer Shop, Custom Engineering, The highly profitable Seminars and Training Business, and many more!

Many new ideas and ground floor opportunities! Interviews and success stories on companies of all sizes! Privy info on the profits made: How some computer store operators net \$100 - \$250,000! Little known outfits that made their owners millionaires, one of these low-key companies, making simple boards, went from nil to \$20,000,000 and 100 employees in four years! Programmers that make \$300,000, Thousands of micro millionaires in the making, etc!

Whatever your goal is - Silicon Valley Tycoon, or just a business at home - we guarantee you'll find a business to suit you - or your money back!

PART TWO of the manual is loaded with the know-how and "streetfighting" savvy you need, both as a novice or business veteran, to get started, to stay and to prosper in the micro computer business! A goldmine of information in clear and easy-to-use instructions: How to prepare your Business Plan, Outside financing, The mistakes you must avoid, How to hire and manage employees, Incorporation ( when, and how to do it cheaply ), Surviving bad times, Record Keeping, how to estimate your market before you start, Use multiple locations to maximize profits, how to promote and stay steps ahead of the competition! How to get free advertising, free merchandise, free advice, Power negotiating with suppliers to double your profit margins, etc! Even how to keep a present job while starting a business part time!

Don't miss this opportunity to be part of this great industry - the next success story could be your own! Order the manual today! Part one and two, bound in a deluxe ring binder, where you can also collect our newsletter ( free for six months with the manual - a \$32.50 value! ) - all for only \$29.95!



#### THE COMPUTER ENTREPRENEUR NEWSLETTER - ALL THE LATEST INSIDE BUSINESS NEWS! NOW! SIX MONTHS FREE WITH YOUR MANUAL!

You're always attuned to the industry, and your manual kept up-to-date, with our newsletter! Each issue has the latest business news, ideas, new suppliers, our indispensable "watchdog" column on profits, discounts ( don't miss mfg's promos, like recently, when top video monitor sold at \$80 - that's half wholesale, one third of the retail price! ), the competition, the big deals, etc! Feature stories with start-up info and case histories on new micro businesses!

You'll get invitations to trade shows and conventions, the usage of our advisory service and our discount buying service for your purchases!

You'll find many items in our newsletter that will save you the cost of your manual many times over!



CALL TOLL FREE!  
CHARGE IT!  
Credit Card Orders  
( MC, VISA only )  
accepted 24 hours/day  
1-800-227-3800  
Ask for extension 1135

In California call  
1-800-792-0990



Order by phone (Credit cards only), or use the coupon:

Mail to THE COMPUTER ENTREPRENEUR PUBLISHING CO.  
PO BOX 456, Grand Central Station, New York, N.Y. 10163

Please send me THE COMPUTER ENTREPRENEUR MANUAL, and the six month free subscription to THE COMPUTER ENTREPRENEUR REPORT/NEWSLETTER. All for only \$29.95, plus \$3 for postage/handling ( NY residents: add \$2.64 for sales tax ). If I decide not to keep the manual, I may return it within 30 days for a full refund.

NAME: \_\_\_\_\_

ADDRESS: \_\_\_\_\_

CITY, STATE, ZIP: \_\_\_\_\_

Check or M.O. enclosed Charge to  VISA  MC

CARD #: \_\_\_\_\_

Exp. Date: \_\_\_\_\_

SIGNATURE: \_\_\_\_\_

TSU 6



## In search of a golden memory

Reviewer Bob Fraser tests three 16K units and finds each falls short of perfection

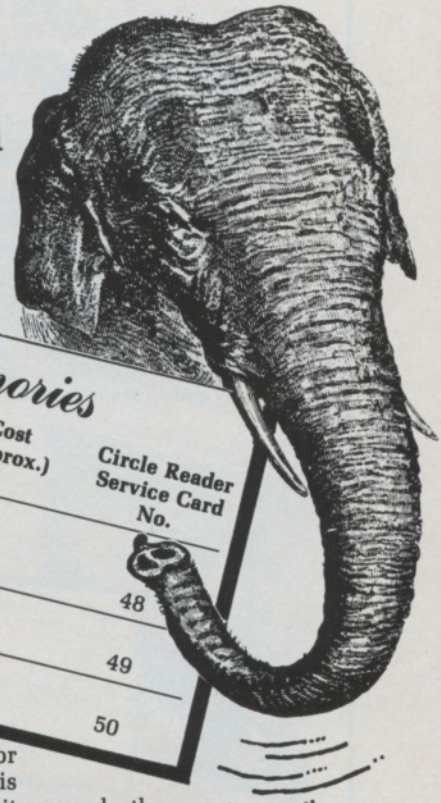

THE MOST important hardware device you can add to your computer is a memory unit. In this article we analyse three memory units for design, flexibility, durability and cost: the Memopak 16K, the Sinclair 16K RAM and the Panda 16K.

These connect to the T/S1000 via the expansion port at the rear of the computer. The design of the unit is very important because it must fit tightly to the computer. If the fit is loose, programs may be lost easily by any movement. This can be very annoying when you are trying to change the tape recorder leads to save a program. We have lost many programs this way.

From the pictures, you can see that the Memopak unit stretches right across the length of the computer. The unit comes with velcro tabs to help make the connection firmer. We have also used tape and elastic bands for the same purpose.

The Sinclair RAM is a smaller unit. It does not fit to the back of the computer as well as the Memopak. We have had great difficulty inventing ways to prevent this unit from wobbling.

The Panda RAM is built similarly to the Sinclair RAM but its fit on the expansion bus is much tighter. We used this unit extensively for two weeks and found no problem with its design.

For design, we feel the best unit is the Memopak. Its structure is best suited

Product	Design	Flexibility	Durability	Cost (approx.)	Circle Reader Service Card No.
Memopak 16K (Memotech)	9	9	8	\$60	48
16K RAM (Sinclair)	6	8	6	\$50	49
ZX-Panda (Stonechip)	8	8	7	?	50

for the T/S1000. We also like its appearance best, although the polar bear on the Panda is a nice touch.

The second category we have defined is flexibility. A memory unit must allow external devices such as printers easy access to the expansion bus. All three memory units allow this but the Memopak has a slight advantage because it also has an edge connector behind it, allowing a printer to be attached in front or

behind it.

The third category for rating memory units is durability. How long will it work? We have used many Sinclair and Memopak memory units and can rate them fairly. The Panda has been only tested for a two week period, so its durability is still questionable.

When we first began using Sinclair computers, we

used the Sinclair RAM. After much use, they began getting warm easily and frequently lost programs. We tried many types of memory units, finding most of them to be unreliable, until we found the Memopak.

The Memopak lasts much longer than the Sinclair RAM. For people with larger memory needs, Memotech also sells 32K and 64K Memopaks. They are of equal quality.

The table shows our rating of the memory units discussed here. We have not rated the Panda for durability after only two weeks of testing, but we will say it hasn't yet caused a single problem. (Stonechip Electronics, a British firm, is currently looking for an American distributor for ZX-Panda, which sells for about £20 in Britain.)



### When the lights go out . . .

THE Cramic-81 is a low-power, battery-backup RAM. It uses up-to-date technology such as lithium batteries to maintain your RAM's contents even when the power is disconnected. It is ideal for keeping large, often used programs, machine code routines or

programs you are working on without the bother of having to load them from cassette each time. This unit can be used in conjunction with another RAM pack and either one can be selected for use by a switch on the Cramic-81. If you happen to wander off for ten years and then return to your machine, chances are the Cramic-81 will still be working and remember where you left off.

For more information, circle reader service number 51.

8/8



# BYTE-BACK modules

**64-K MEMORY \$129.95** KIT

\$139.95 ASSEMBLED & TESTED

*In Stock!*

*With*

**BATTERY BACKUP**



**BYTE-BACK'S MD-1**

**MODEM \$119.95** KIT

ASSEMBLED & TESTED \$149.95

Use your phone to connect your "LITTLE" computer to the "LARGEST" computer networks in the world. With **BYTE-BACK'S MD-1 MODEM** connected all you do is dial a phone number (usually local), press a few keys and watch the data appear on your TV screen. (Software is included) This **MODEM** can be used in either the "originate" or "answer" mode with selectable baud rate.

**You can have immediate access to: UNIVERSITY COMPUTERS, DOW JONES, UPI COMPUSERVE PACKAGE WITH 5 FREE HOURS ONLY \$34.95**

As an extra bonus an RS-232 port is provided to allow you to drive all standard RS-232 peripherals. (75 to 9600 Baud.)

**BYTE-BACK'S BB-1 CONTROL MODULE**  
**\$59.00** KIT *In Stock!*

ASSEMBLED & TESTED \$69.00

- **8 Independent Relays**  
*(with LED status indicators)*
- **8 Independent TTL Inputs**  
*(with Schmitt trigger buffers)*



- By using a single POKE command you can change and latch the status of each of the 8 relays.
- Your computer can read the status of all 8 inputs by the use of a single PEEK command.
- A comprehensive manual is included that has complete application details.
- More than one BB-1 can be used at a time.

the "ULTIMATE MEMORY" **UM-64**  
**FEATURES:**

**NEW**

- Battery backup
- PROM/ROM socket
- Reset Switch.
- **BYTE-BACK EXCLUSIVE FULL 64-K**

The 0-8K area is available. You can execute a copy routine (provided) to copy the TIMEX ROM into the 0-8K area of RAM then flip a switch and you have your operating system in RAM. You can modify it and create your own customized operating system. Full details, examples & programs included.

**WHY PAY MORE FOR LESS FEATURES?  
GET THE "ULTIMATE MEMORY"  
BYTE BACK'S UM-64**

**16K MEMORY UM-16 \$59.95** kit \$69.95 assembled & tested.

Battery backup, reset switch, PROM/ROM socket PLUS. . . . 1 year, 100% trade-in credit towards the **UM-64**.

**RS-232 Module \$59.95**

ASSEMBLED & TESTED \$69.95

Allows you to connect your computer to all RS-232 printers & terminals

**ALL MODULES CARRY 90-DAY WARRANTY**  
TRY BYTE-BACK MODULES FOR 10 DAYS WITH NO OBLIGATION

**BYTE BACK KEYBOARD**

**\$89.95**

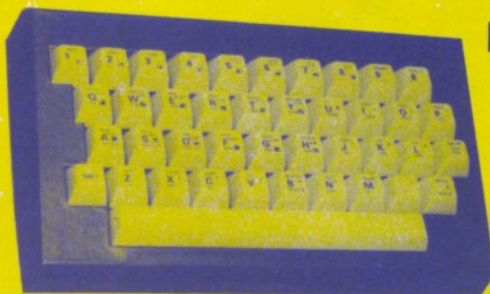

We use the same key switch found in the expensive computers such as: Hewlett Packard, Texas Instru-

ments, Atari, D.E.C. etc. The multi-colored key caps are the same type used on the IBM Personal Computer, but with the TIMEX ledgens.

**EXPERIENCE QUALITY**

1

Shipping and Handling \$4.95

ORDER PHONE (803) 532-5812

ITEMS ORDERED: \_\_\_\_\_

Bill My  Am. Exp.  Visa  M/C  
Checks Accepted

Exp. Date \_\_\_\_\_ Card No. \_\_\_\_\_

Name \_\_\_\_\_

Address \_\_\_\_\_

City/State/Zip \_\_\_\_\_

Phone \_\_\_\_\_

*Dealer Discounts Available*

Mail To: **BYTE-BACK CO.**  
Rt. 3, Box 147, Brodie Road  
Leesville, S.C. 29070





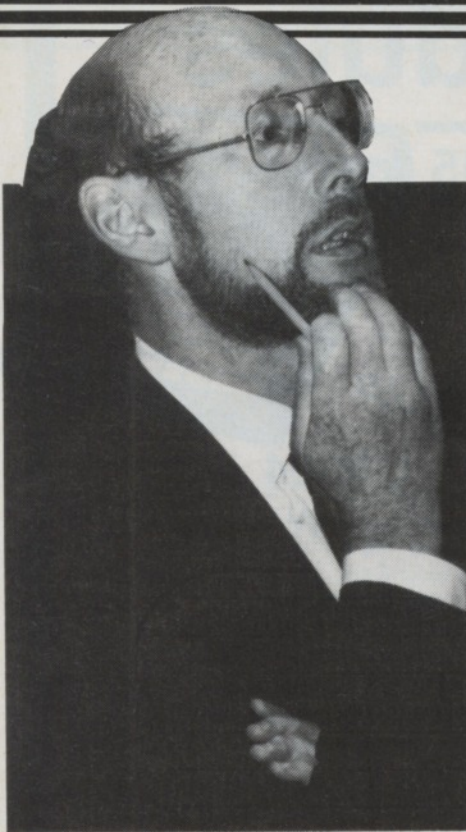

## Clive sells 1.6 million computers . . .

Sinclair Research has claimed to be the first company to sell more than one million home computers.

Since it began selling the ZX80 three years ago it has sold 130,000 ZX80s, 750,000 ZX81s and 200,000 Spectrums, an upgraded version of which is to appear soon in North America as the T/S2000. And these figures

*CLIVE SINCLAIR: neither young nor a businessman*

do not include the 600,000 T/S1000s sold since it was launched in July last year.

The claim to be the first past the million mark is disputed by Commodore, which claimed it had reached that point last year.

Clive Sinclair, chief executive and chairman, said he is very pleased with the figures. "They are a magnificent achievement for all concerned. With the ZX81 entering its third year of production the figures demonstrate beyond doubt the long-term viability of the computer as a long-term consumer product."

More than 200,000 Sinclair or Sinclair-based computers are now sold every month throughout the world.

## . . . and snags award

The British newspaper *The Guardian* has named Clive Sinclair as the Young Businessman of the Year. The award is made annually to people in Britain who have shown particular ability in business.

Past winners have included Sir Michael Edwards, the man responsible for improving the fortunes of Britain's state-owned carmaker BL.

The award has caused some amusement as Clive claims to be neither young nor a businessman. At 42, he is more than twice the age of many of the young entrepreneurs now reputed to be making vast sums from the rapid growth of the home computing market in Britain.

• See our profile of Clive Sinclair beginning on page 62.

## No Faire for Timex

Fifty thousand people agreed that the 8th West Coast Computer Faire, held in San Francisco from March 18 to March 20, was fantastic. It boasted 500 different exhibitors ranging from the small single-booth entrepreneur selling tapes and books to the "big guns" like Apple, Commodore and I.B.M. No, we didn't forget to mention Timex, they just didn't bother showing up. We don't know why they weren't there, but a lot of Timex Sinclair owners were awfully disappointed with Timex's apparent lack of interest and support.

On a brighter note, Jim Warren, known as the Faire Chair, was delighted with the great turnout. You would be too, I'm sure, with 50,000 in attendance at \$15 a head, which, to be fair, did let you in for all three days.

For those looking to learn, there were seminars, lectures, workshops and interest groups. The business person could shell out an

extra \$125 to hear Arnold Roberts talk for five hours on "How to Select a Business Computer." Others, for free, listened to, worked at, and struggled through such sessions as "Venture Financing for New High Tech Companies", "LOGO & Kids", "Word Processing", and "The Esoterics of Computer Games." For those yearning for fun, there were video games in abundance . . . and all free.

Next year they'll do it all over again. Same place, same time, but hopefully better weather. The 9th West Coast Computer Faire, which takes place March 23 to 25, 1984, is still looking for speakers. If you have a talk you know people are waiting to hear, call or write:

Computer Faire  
345 Swett Road  
Woodside CA 94062  
(415) 851-7077

The deadline is November 30th, 1983. We'll see you at the Faire!

— Joseph Gladstone

## U.K. Hoax Exposed

Last April, the British counterpart to this magazine, *Sinclair User*, ran a program entitled "Machine Code Converter"



that was amazingly economical — only 27 lines long. "Now a brilliant piece of programming enables the Basic programmer to convert his listing automatically into machine code by LOADING from a tape or by entering the program line by line from the keyboard," claimed the instructions alongside the program. But readers discovered differently when they tried it and found an unexpected message printed on their screens: APRIL FOOLS!

"We got great feedback on this," says Editor Nigel Clark. "Most of our readers just loved it. But one man was so disgusted he cancelled his subscription."

Oh well, seems some people can't take a joke. ☺/☺



# SPECIAL OFFER



Get the best of British Sinclair with ...  
The Sinclair User Annual

**NOW** — the best programs, advice and features from the top Sinclair computer magazine in the U.K. are available in North America in Sinclair User Annual!

**SINCLAIR USER ANNUAL** — from the home of the Sinclair (Timex) computer comes the best of the top-selling magazines, Sinclair User, Sinclair Programs and Sinclair Projects!

**TIMEX SINCLAIR COMPUTERS** — originated in the U.K. three years ago where there are now over one million users. Sinclair User Annual gives you the cream of their programs, projects and ideas!

**T/S1000,ZX81** — get more fun, more knowledge, more programs, practical projects, hints and tips from other enthusiasts. Take advantage of their experience to get more from your computer.

**YOU GET** — 116 pages including exciting software and hardware reviews, graphics ideas, 19 pages of program printouts, a Spectrum (T/S2000) preview, technical information, programming help ... and much more!

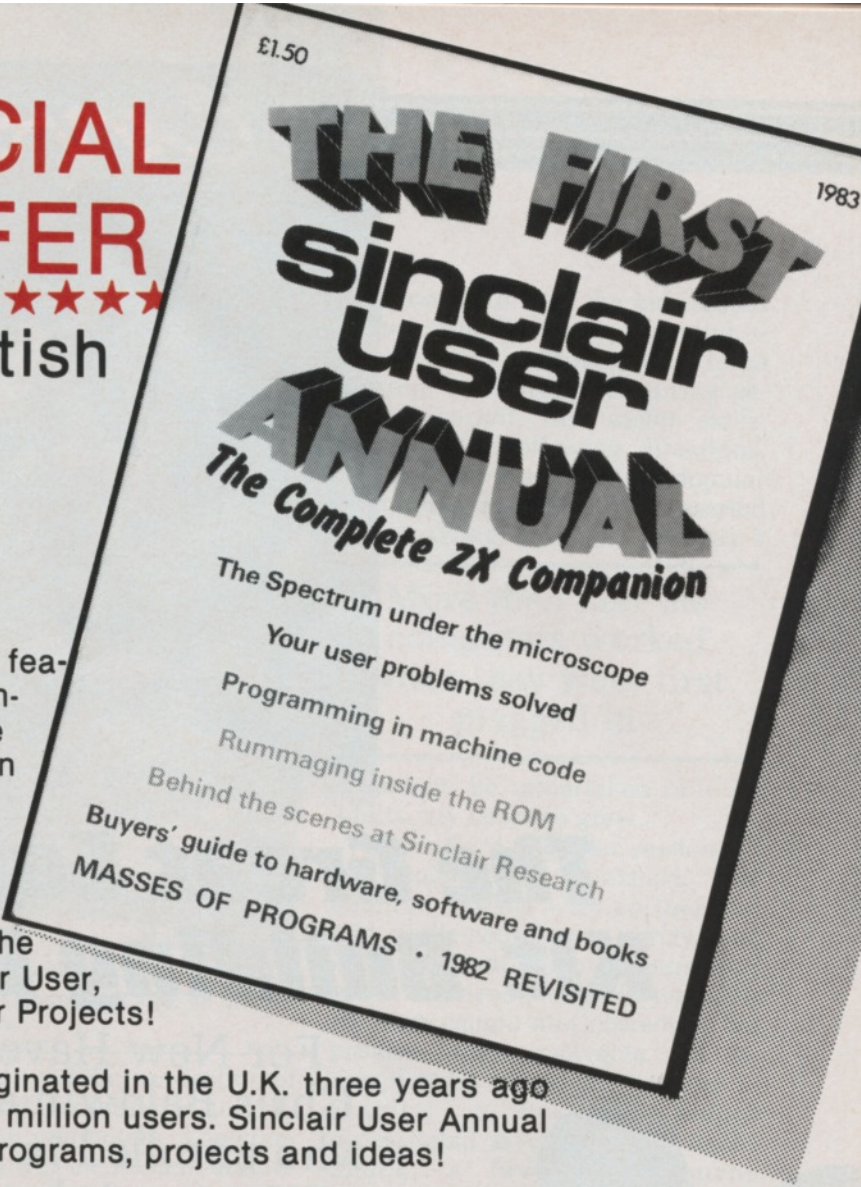

U.K. price ..... \$4.00  
(including handling & shipping)

**SAVE 30%**  
MAIL THIS COUPON TODAY!

**ONLY \$2.75**

Please rush me \_\_\_\_\_ copies of Sinclair User Annual at \$2.75 each (includes shipping and handling).

Timex Sinclair User  
c/o Special U.K. Offer  
49 La Salle Avenue  
Buffalo, N.Y. 14214

PAYMENT ENCLOSED

- CHECK
- MONEY ORDER
- VISA
- MASTER CARD

\_\_\_\_\_ card number \_\_\_\_\_ expiry

\_\_\_\_\_ signature

Allow 6 weeks for delivery.

\_\_\_\_\_  
Print Name

\_\_\_\_\_  
Address

\_\_\_\_\_ City \_\_\_\_\_ State \_\_\_\_\_ Zip





## ***The Great Connecticut Kit-Building Experiment***

For New Haven teacher  
Chris Baldwin and 28 kids  
who enrolled in his 10-week  
ZX81 workshop, it was a  
resounding success

**I**T USED TO BE THOUGHT, and still is in some school systems, that programming instruction and hands-on computer time belong in the high schools. It is now finding its way into the grade schools, more often as a result of student and parent pressures than of the vision of school boards. I've seen typical nine and ten-year-olds program in BASIC, and six and seven-year-olds in Logo. Kids with this learning opportunity have a tremendous, perhaps decisive, advantage — but only a few have this opportunity! Until schools recognize their responsibility and

“The children worked with an intensity and excitement I have rarely seen in my years of teaching”



provide every child with daily access to a computer, this sad waste will continue.

That's a strong statement, but the more I work with children and computers, the more I see what the experience can mean to a child's self-image. I know a child has made an important breakthrough in how she sees herself and her world

---

**"The more I work with children and computers, the more I see what the experience can mean to a child's self-image"**

---

when she stops asking 'How do I do X?' and begins saying, 'I wonder if this will do X?' She returns to a natural approach of playfulness and discovery about her world in a school setting in which many pressures work to dull that approach.

One point I continue to make to policy-makers (with limited success to date) is to ask them to carefully consider which expenditure of \$2,200 best serves a school's needs: one Apple II with a monitor, printer and disk drive, or eight T/S1000s, televisions, cassette recorders, printers and 16K memories? Through my work with kids and computers, I became convinced of the importance of giving all children free access to computers.

**I**N THE SPRING of 1982, I placed an ad in the school newspaper offering to help kids build ZX81 kits. Parents were to pay \$150 for a kit, all supplies, and my time: a reasonable charge as the complete ZX81 alone was then selling for that price. I expected half a dozen replies: within four days I had 28, mostly from 10 and 11-year-old boys. In this age group it is hard to attract girls to what they already see as a male realm.

There was no screening of kids for this workshop. They



Chris Baldwin (above) and kids: no problem was unsolvable.

represented a valid cross-section of abilities and experience in kit-building and computers. The common thread was excitement and interest about computers. Most did not know how to solder; most did not know what soldering was. Could youngsters master this delicate art?

As the starting date approached, my wife's worries that I had bitten



off more than I (or the kids) could chew raised doubts in my mind — doubts about working with so large a group on a project requiring patience, certain fine motor skills, and care in following directions. When I saw a review in a popular computing magazine that asserted that building the ZX81 kit was a

---

**More than half the computers worked when they were first plugged in**

---

project to be undertaken only by adults, my concern grew.

By the third two-hour session, all our doubts had vanished. The children worked with an intensity and excitement I have rarely seen in my years of teaching. Sure they made mistakes along the way, but all were caught and corrected. No problem was unsolvable. An incomplete kit necessitated a letter to Sinclair; a few lost pieces necessitated several trips to Radio Shack; a few solder burns necessitated we keep first-aid supplies handy. I threw my back out and conducted several sessions flat atop a table.

I anticipated the children would finish in six or seven sessions and spend the rest of the time using their computers; week by week, anticipation and worry grew over whether the computers would work.

They were completed between the eighth and tenth sessions. When we plugged them in for the first time, more than half worked right away; after faults were discovered and repaired (the most common were shorts in the sockets and under the keyboard connectors) most of the others also became functional. Only one had multiple problems, including a cold solder, which took longer to track down. In the months since, there has been only one failure we have not been able to correct ourselves.

You see stories in the local press headed, "Whiz kid builds own com-



# NEW RELEASES!



INTERNATIONAL PUBLISHING & SOFTWARE INC.

## TINY LOGO

- \*Teach your children programming skills through a computer graphics language
  - \*Comprehensive guide included
  - \*Easy and fun to use
- (Tiny Logo is a subset of the popular Mit Logo)

\$19.95



## COMPUTERIZED DIET PROGRAM

(For the whole family)

- \*Complete assessment of your eating habits and eating needs
- \*Totally nutritionally balanced menus developed especially for you
- \*Continual computer tracking of your personal progress
- \*Vinyl storage case and booklet included

(2 tapes) \$29.95

## THE TRADER TRILOGY

3 full 16K Programs!

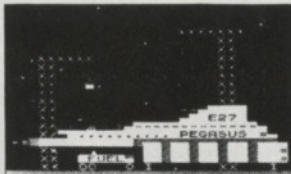

It is hard enough to look at an amorphous hydrosillicon blob from P.S.I. never mind swing a deal with one. But when they ask to pick your brains....

\$14.95



## A MUST FOR EVERY SERIOUS PROGRAMMER

- \*Load and save programs up to 6 times faster
- \*Easy to use in your own programs
- \*Now available for 64K RAMS

\$19.95



TS1000-ZX81 OWNERS  
WIN \$20,000  
ENTER THE ULTIMATE ADVENTURE

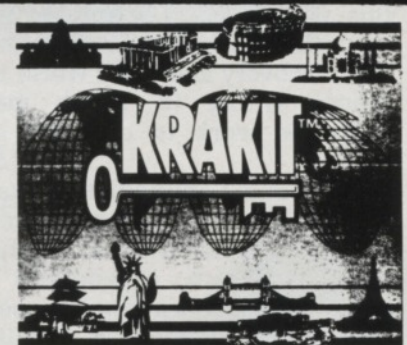

Travel the world with your TS1000/ZX81 computer. Answer the 12 riddles and WIN!!

\$19.95

## SOFTWARE WRITERS I.P.S. NEEDS YOUR PROGRAMS!

- \*Highest royalties paid
- \*Highest quality artwork and documentation
- \*Distribution throughout the world!
- \*Take advantage of our Fastload system.

CONTACT US SOON!

ASK YOUR DEALER FOR I.P.S. PRODUCTS BY NAME

\*Dealer and distributor enquiries invited



For more information, circle 5 on Reader Service Card.



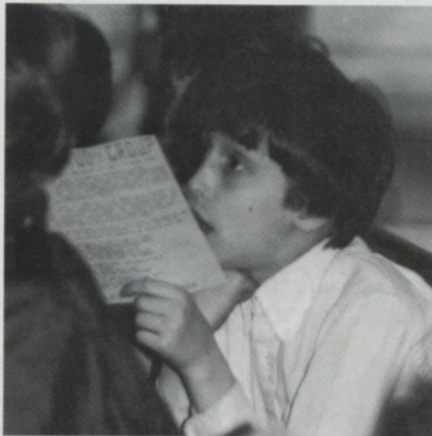

puter," but it somehow seems too frequent an occurrence to justify calling anyone a whiz. I believe that just about any 10-year-old could do it if given the opportunity and minimal guidance.

Last September, I started the New Haven Sinclair Study Group to provide continuing stimulation for kids using Sinclair computers. We meet on alternate Tuesday nights through the school year. Half

## "Can 11-year-olds master the delicate art of soldering?"

of each meeting is given to a discussion demonstration or lesson, and the other half to sharing work, comparing problems and exchanging ideas.

I LIKE TO TELL KIDS that the Sinclair case is black only to those who will not look at it; to anyone who uses the computer, the case is really transparent and Clive Sinclair meant for everyone to see inside it and understand it and put it to work in new and better ways. I hope the kits become available again and that the T/S2000 finds a place in our schools. That way, we can live up to Clive Sinclair's philosophy of bringing computer power to all the people. Computers are very powerful tools, and we need to see ourselves in a position of mastery, not intimidation. ☺/☺

— As told to **Ross Williams**

## Comments from the Kids

WE ASKED THE MEMBERS of the New Haven Sinclair Study Group to tell us about the ZX81 and their experiences building it. Some of their comments:

"I can remember the first day of the computer club how scared I was. It seems silly to think of it now but I was really scared, I thought I would get burned or something. It looked so confusing I mean when I opened the box the parts were kept in for the first time all I saw were tons of little odds and ends. These odds and ends are now my ZX81."

— **Avery Grauer**, age 11

"I can barely remember trying my first solder. I was so nervous I could barely hold the soldering iron. After I had completed my first solder, I thought, well, I've only got 299 solders to go! And believe me those 299 solders were not easy!"

— **Kent Zimmermann**, age 11

"I kept messing up by filling holes with solder and putting diodes in the wrong holes. After I finished, it did not work, but with some adjusting it worked fine."

— **Jennifer House**, age 11

"It was fun building it."

— **Andy Cohen**, age 9

"It is so small, light-weight and compact it's hard to believe it is a computer."

— **Wyeth Friday**, age 11

"The ZX81 is a very good first computer. There are a lot of things you can do with just 1K that you wouldn't dream of doing when you first get it home."

— **Michael Slavinsky**, age 11

## Ode to the ZX81

THE New Haven Sinclair Study Group held an essay contest for which entrants were required to write a statement of 81 words or less "explaining why you think the Sinclair is super." Eleven-year-old Matthew Quinlan won a copy of the 1K game *Break Out* for the following:

The ZX81 is compact and easy to use,  
It can do anything but tie your shoe.  
Small and easy to lose,  
No zapping to give you the blues.

Takes you on paths yet unexplored,  
You can play it at home and not get bored,  
You don't even need an 80-column board.

Plan your diet and not get fat,  
Like learning Basic is really hip,  
I mean gag me with a microchip!

Really awesome, Matt! Like wow!



# Get serious about ZX81 & TS1000 Computing

## Cassette Software

### ZX FORTH

A complete implementation of the FORTH language for the ZX81 and TS1000 computer. FORTH's most distinctive feature is its flexibility. The basic unit is the word — the programmer uses existing words to define his own which can then be used in further definitions. FORTH is a compiled language so programs run very fast! (typically five times faster than BASIC). ZX-FORTH is supplied on cassette and is accompanied by extensive documentation:

- 56-page Users Manual
- 8-page Editor Manual

**Z43 \$29.95**

### ZX BUG

**Machine Code Monitor and Disassembler**  
 ZXBUG is a powerful tool for machine language programming. It is 4K long and uses memory from 71E0 to the top memory. ZX BUG works in hexadecimal (base 16), not decimal, so all addresses are a maximum of 4 Hex bits long. Provides a total of 28 commands.

**Z41 \$14.95**

### ZX ASSEMBLER

This Machine Code program occupies 7K of memory and locates itself at the top of memory. The program is a full Editor/Assembler and Monitor. Labels may be used instead of any string. The features include Line Insertion/Delete, Insert Characters, Auto Repeat on all keys. The monitor has facilities to inspect memory, registers and run machine code programs.

**Z40 \$14.95**

### TOOLKIT

**9 Powerful New Functions!**

**RENUMBER.** This routine renumbers a program in any step and from any line up to 9999  
**DELETE.** This command deletes a group of lines in a program.  
**MEMORY.** Prints how much spare memory is available.  
**DUMP.** Displays current values of string and numerical values, except arrays.  
**FIND.** Will find any string of up to 255 characters and list each line containing that string.  
**REPLACE.** Replaces any string of up to 255 characters by any other string.  
**SAVE.** Transfers program in computer to below RAM-TOP.  
**APPEND.** Allows two programs to be joined.  
**REMKILL.** Removes all REM statements from a program, otherwise leaving it unchanged, preserving memory.

**Z42 \$14.95**

### Z-AID1.0

Includes the following routines:  
**VERIFY** confirms whether a program has been recorded properly on tape. The program in memory is unaffected, and a further "save" can be made if necessary.  
**Mload/Msave** enables a specified block of memory to be saved. VPTR can be used within a BASIC program to eliminate many tedious POKEs and PEEKs in finding the addresses where variable values are stored.  
**CHAIN** allows the second part of a BASIC program to be loaded and tacked onto the end of the first part.  
**Z-AID 1.0** is convenient to use, being loaded from tape, and residing at the top of 16K memory. The user accesses the various routines with USR calls while loading, running, editing and saving BASIC programs normally.

**Z98 \$14.95**



**Z61 \$19.95**

- ★ Allows you to LOAD and SAVE ZX81 programs up to 6 TIMES FASTER!
- ★ Easy-to-use in your own programs.
- ★ User-transparent when incorporated into programs.
- ★ Verifies proper loading.
- ★ Catalogue feature lists program names and memory usage.
- ★ LOADER occupies less than 500 bytes (½ K) of RAM.
- ★ Consists of 2 separate programs — KEYBOARD MONITOR and FAST LOADER.
- ★ Supplied on cassette with extensive documentation.

### TINY LOGO



Teach your children programming skills through a computer graphics language. It's easy and fun to use! Included with your program is a comprehensive guide. (Tiny Logo is a subset of the popular MIT Logo)

**\$19.95**

**New! Write for your's Today!**

**FREE  
 ZX81/TS1000  
 CATALOG**



**The Complete ZX81 and TS1000 Library!**

### BOOKS

The Complete ZX81 Basic Course	
Basic Course Cassettes (2)	B70 \$29.95
Getting Acquainted with your ZX81	C70 \$8.95
ZX81 Pocket Book	P70 \$10.95
Making the Most of Your ZX81	P71 \$10.95
Computer for Kids, ZX81 Edison	C71 \$4.95
Explorers Guide to the ZX81	T70 \$12.95
ZX81 Companion	C72 \$8.95
49 Exploding Games for the ZX81	P72 \$10.95
Not Only 30 Programs for ZX81: 1K	B72 \$9.95
Machine Language Made Simple	B73 \$14.95
Mastering Machine Code on your ZX81	P73 \$12.95
ZX81 Rom Disassembly: Part A	Both for
ZX81 Rom Disassembly: Part B	\$19.95
Understanding your ZX81 ROM	B76 \$14.95



**\$99.95**

### KEYBOARD

**with metal case K71**

A full-sized professional keyboard for the ZX81 Features 47 keys and a full-sized space bar. Connects to the ZX81 with no soldering required, via a plug-in flexible connector. You can purchase the keyboard only, or the optional metal case that holds both keyboard and ZX81. Expansion devices (i.e. RAM packs, etc) connect to the ZX81 edge-connector which extends from the rear of the cabinet.

● American made ● Keycap legends will NOT wear out ● keys with life rated at 20 MILLION cycles

**Keyboard K70 \$79.95**

**Metal case for keyboard and ZX81 E70 \$25.00**

### GLADSTONE 64K RAM

Expands the capacity of the T/S 1000 or ZX81 to its maximum. User transparent. **G64**

**Special \$129.95**

### CRAMIC-81 16K CMOS RAM

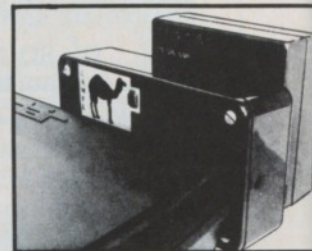

**NEW RAM PACK STORES 16K EVEN WITH POWER SWITCHED OFF**  
 CRAMIC-81 is a 16K RAM pack using CMOS technology for permanent data retention. Data can be stored almost indefinitely and loaded almost instantly with virtually zero chance of error.

CRAMIC-81 module uses chips made in a special CMOS technology which require only a tiny amount of power to retain data when not actually in operation. A state-of-the-art, long life (10 years) lithium battery supplies this power in the standby mode. In the active mode, power is taken from the ZX81. Used on its own it behaves like an ordinary Rampack EXCEPT that it can be powered down and removed. Program and data in it is permanently stored when this is done.

An ordinary Rampack can also be connected simultaneously. The two RAM units then occupy the same memory area but either can be selected. Two separate programs can actually run alternately.

CRAMIC-81 comes in an elegantly molded lie-flat case with a cabled connector.

**C12 \$179.95**

**GLADSTONE-ELECTRONICS**

**In N.Y. (716) 874-5510  
 Toll free (800) 833-8400**

**Mail order to 1585 Kenmore Ave. Buffalo N.Y. 14217 Checks or money orders. No CODs. Add shipping**

TIMEX SINCLAIR USER







## Computers as teachers: do they work?



*Pictured is a prototype of the T/S2000.*

Computers are in our schools now, and students are using them every day. Are they dehumanizing? Do they teach anything? Will teachers reject them? Charles Durang, science and computer editor for Reston Publishing, explores some old computer myths

**C**AN you remember, not too long ago, when no one thought computers would get into the education business within our lifetimes? We heard most of the following:

"We won't use computers in our

schools because they are too expensive."

"Computer-aided instruction is dehumanizing — it's mass-production, lockstep, standardized education."

"The computer can be a very

useful tool, but the teachers and administrators are too conservative. They may also be afraid of being replaced by the machines. It will be a long time before computers are accepted in the schools."

"It's another form of programmed instruction, and look what a bust that was."

Well, it's time to take another look: each of those statements bears a little examination in the light of what's been going on during the last year or two.

Prices of all computers have been dropping rapidly, and with the advent of the under-\$100 Timex/Sinclair 1000 (nee Sinclair ZX81), there is no school district — and few families — too poor to jump on the computer bandwagon. One company is producing a



package including computers, monitors, cassette storage units, software and perhaps printers — at

## **“Computers are too expensive”**

a price for ten systems that compares to the price of one Apple-based system!

Today, the computer is proving, when employed for simple drill-and-practice exercises, to be more individualized, more self-paced, more forgiving and less judgmental than any teacher and classroom environment can be. Computer-aided curricula are able to be more truly “competency-based” than anything that has gone before.

For inductive kinds of learning (although this kind of thing is clearly in its infancy as far as currently-available software goes), a computer program can support and manipulate a large data base for student exploration and discovery of facts and relationships — at the student's pace, at the student's direction, using the student's

## **“Computer-aided instruction is lockstep education”**

methods. We can learn how to learn even as we learn facts!

The misconception that lay beneath a lot of the anti-computer rhetoric was this: on the one hand you have a teacher, a living, feeling human being who will be sensitive to all the students in class and adjust the environment to help them; on the other hand is the machine, inflexibly programmed to proceed at its own pace.

The reality is that the teacher cannot address every student's needs simultaneously — in fact, the classroom environment mandates lockstep methods — while behind the computer is another thinking, feeling human being who wrote the program the student is using. The student is not learning from the computer, but from the program —

ultimately, from the teacher who created the program. By repeating tirelessly at the student's option, moving ahead rapidly in response to student progress, and trying alternative approaches to the same concept when indicated, the computer provides the true self-paced and individualized environment. And the uncertain student will find his confidence growing in response to the program's encouragement, rather than shrinking because of classmates' derision or a teacher's ill-concealed dismay.

Teachers are rapidly overcoming their legendary (and, it appears,

## **“The educators are too conservative”**

largely fictitious) “computer anxiety” and recognizing the potential of this new medium. They are actively seeking to put the machines in the classroom; principals and superintendents are putting them in the budget.

A recent survey by Market Data Retrieval shows that 24,642 school districts in the U.S. now use computers for instructional purposes, including 10,499 of the nation's 52,000 elementary schools (an increase, at the elementary level, of 80 per cent over last year).

There is the recognition, on the part of parents as well as teachers, that today's students will have to understand and be able to deal with computers to survive in tomorrow's world.

There is also — though it is a secondary consideration — the fact that the computer's basic data processing capability for record-keeping makes it easy to administer each student's program in a way tailored to the individual.

Most important, of course, is the fact that educators realize the potential of all we said above, and that the microcomputer as “teacher's aide” can provide both

**“The computer is . . . more forgiving and less judgmental than any teacher . . .”**

remedial and advanced self-study — at ever-declining cost — to supplement the teacher's own efforts.

## **“Programmed instruction was a bust”**

There is little doubt of the truth of that statement, and there certainly is a relationship between programmed and computer-programmed instruction. There is even the chance that computer-aided learning will indeed suffer the fate of its predecessor. But the differences are encouraging:

1. The climate today is more receptive to a new approach.
2. The computer is innately more powerful, and more interesting to the students, as a tool.
3. The potential economic rewards are such as to attract the best people (educators as well as programmers) to the software effort.

There is a lot of educational software out there already, but much more is needed. It is likely that, this time, the good will drive out the bad, rather than the other way around.

Perhaps the most exciting facet of the computer-assisted learning movement is the extent to which computers are being used at home for education of all sorts, and for every member of the family!

Parents are eagerly rushing to purchase personal computers to help their children learn at home —

## **Computer-aided learning at home**

either because there are computers in the local schools, or because there are not! The resulting pressure from the home front is likely not only to speed the introduction of computers into schools, but also to improve the quality of education in general.

Such programs as Reston's Self-Teaching Software for the ZX81-TS1000: Mathematics I-VI are likely to be found much more extensively in homes initially, and find



# TS1000-ZX81 OWNERS WIN \$20,000

ENTER THE ULTIMATE ADVENTURE



**SOLVE 12 CLUES LIKE THIS!**

*Where it all began. Where the torch was first lit.  
Where muscles and sinews strain. Where our heroes  
win acclaim. Where the symbols hold the key.*

KRAKIT™ consists of 12 clues on a ready-to-run ZX81 or TS1000 cassette tape (16k RAM). The answer to each clue is the name of a country, a city or town, and a number. If you are the first qualified entrant to solve all 12 clues and declared the winner, you receive two tickets to the city of the secret KRAKIT™ vault location. When you arrive at that location, a check for a minimum amount of \$20,000.00 (U.S.) will be presented to you. The amount of the prize money is augmented weekly.

## TS1000 - ZX81



Mail to:  
**INTERNATIONAL PUBLISHING & SOFTWARE INC.**  
P.O. BOX 1654, BUFFALO, N.Y. 14216

Please send \_\_\_\_\_ copies of KRAKIT™  
at \$19.95 plus \$1.50 shipping.

Total \_\_\_\_\_ enclosed is  check

money order

Charge to  Visa  Mastercard

Number \_\_\_\_\_

Expiry \_\_\_\_\_ Signature \_\_\_\_\_

Please print:

Name \_\_\_\_\_

Address \_\_\_\_\_

City \_\_\_\_\_ State \_\_\_\_\_

Zip \_\_\_\_\_

Allow 2 weeks for personal checks.

For more information, circle 17 on reader service card.



their way into the schools somewhat more gradually.

Also, because learning is not just for kids, many adults without children are buying home computers specifically to learn new skills or topics. People who cannot afford the time or money to take courses, or who are embarrassed for one reason or another about being seen in a class, are embarking on their own programs of individualized learning.

You can certainly anticipate the first suggestion from this corner: go get a computer if you don't have one! The Timex/Sinclair 1000 is a good starting place. While it is not a competitor to Atari for games, or to IBM for business applications, it is a superb learning tool — and a sophisticated machine that the programmer will not outgrow as he progresses from novice to expert.

Second, be conscious of the computer as an educational aid at home. Look for appropriate software for learning, not only for the children but also for the adults in the family. Remember this: your home computer is not only good for learning about various topics . . . and not only for learning about computers because they will be all around us for the foreseeable future . . . but also for learning about thinking and problem solving.

Someone has said, and many have repeated it, that the computer will always do exactly what you tell it to do, which is not necessarily the

## What can I do now?

same as what you want it to do. Learning to program a computer, even at a very rudimentary level, teaches clear thinking and problem-solving analysis in a way that the freshman Logic course always aspired to do.

Don't worry if, when you bring home your computer, your children only want to "play games." First, they will learn from the games. Second, they will next want to make up their own games — they will learn to program. And, perhaps

later rather than sooner, but almost inevitably, they will put that programming knowledge to work in other areas.

Educators, students, parents,

learners: you cannot go wrong by owning a computer today. You may not learn what you thought you were going to learn. But learn you will!

## How educational are the "educational" programs?



Joseph Gladstone  
Former educator  
evaluates some  
teaching software

**K**IDS DO LEARN from using computer games. This does not make those games educational programs. To be educational, a program must teach something that somebody planned to teach. In the jargon of the schools, that is called a learning objective.

Further, to be educational, a program must show somehow that the kid has learned that objective. In a game, that's easy. You can see how well the player does . . . how many aliens were stopped or how many dots, dashes or stars eaten.

Games also have, built-in, the thing teachers call "motivation." That is, kids want to do it.

Putting these elements together, we see that an educational program should have a specific goal, should motivate the child to do the work well, and have a testing system built into it. With all this in mind,

we looked at five different educational programs available for the T/S1000,ZX81.

MINDWARE'S Multiple Choice program begins with clear screen information and instructions, and guides the student very well through each stage. Basically, this program is a set of questions ranging from, "What is the capital of New York state?" to "What is the square root of 2?"

What the test does, it does okay. It does not meet our simple requirements, though, to really classify as an educational program. It does not hone in on specific learning objectives. It does not teach anything. It does give a general information test.

The more important part of this program is its ability to let you (student, parent, or teacher) create your own test. You put the problems and answers into the program. Multiple Choice leads you clearly and easily through that process. In this mode, the program accepts questions and answers of up to 32 characters each. After you have created your test, you can save it for later use. Thus you (teacher, student or parent) can create a file of tests on different subjects and of varying difficulty.

Another program that lets you create, save and re-use your own tests is called Flashcard. A flashcard is a device used in many classrooms. It has a problem or question on one side and a solution or answer on the other. On the T/S1000,ZX81 version, you put problems on as many as 100 cards, and answers which are then mixed by



## TIMEX 1000 COMPUTER

**\* OWNERS \***

IF YOU OWN A 16K RAM MODULE  
THEN YOU NEED A "CRASH GUARD"  
TO HELP SOLVE YOUR WOBBLE AND  
CRASH PROBLEMS

- \* NO DANGER BUMPING THE MODULE
- \* PROVIDES A SOLID WORK BASE
- \* MADE OF HEAVY GAUGE ACRYLIC

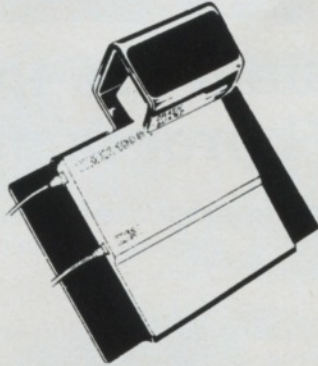

**\$19.95**  
ADD  
\$2.00 S. & H.

VISA OR MASTER CARD ACCEPTED  
**EXPENSE CUTTERS PRODUCTS, INC.**  
P.O. BOX 9543 RAYTOWN, MO 64133  
(816) 353-1690

10 DAY TRIAL PERIOD  
"SATISFACTION GUARANTEED"

For more information, circle 10 on reader service card.

### SATISFACTION GUARANTEED OR YOUR MONEY BACK TS-ART

TS-ART helps you **create graphics** on the screen with a pencil, an eraser, about 120 brushes, a video inverter and a "flicker". You can easily move these tools in 8 directions or along lines or circles which are drawn, erased, painted with a brush, video inverted or "flickered". You can set a different background to any quarter of the screen. You can **define new graphic commands** — for example one that "does" a square. Then by pressing only one key you can make any of the tools do a square anywhere on the screen; so a square can be drawn, erased, painted, and so on. And the square can be rotated and it can be compressed or expanded to any size. And it can be used as a building block for other commands you define. And you can save or print the artwork. And . . .

TS-ART is very easy to learn and use, so 4 year old kids master its basic commands in minutes. Yet it is powerful and sophisticated to satisfy the most creative user.

TS-ART is fun; is a screen editor that can mix text with graphics; is a smart **educational device** (ages 4 to 99) that indirectly teaches (**LOGO style**) concepts in arithmetic, geometry and computer science by making abstract ideas visible and concrete.

All this power (and more) for only \$12.95 (add \$1.50 for s & h in U.S. or \$2.50 outside U.S.). 16K RAM.

**Win \$50** if we use your artwork in our ads.

**KSOFT**, 845 Wellner Rd., Naperville, IL 60540.

Name \_\_\_\_\_  
Address \_\_\_\_\_  
City/State/Zip \_\_\_\_\_  
 Check  VISA  MC  
Card Number \_\_\_\_\_ Exp. \_\_\_\_\_  
Phone Orders (312) 961-1250

For more information, circle 12 on reader service card.

## ELECTRONIC Klik Keyboard

AN ALTERNATIVE  
NOT AN ADD ON

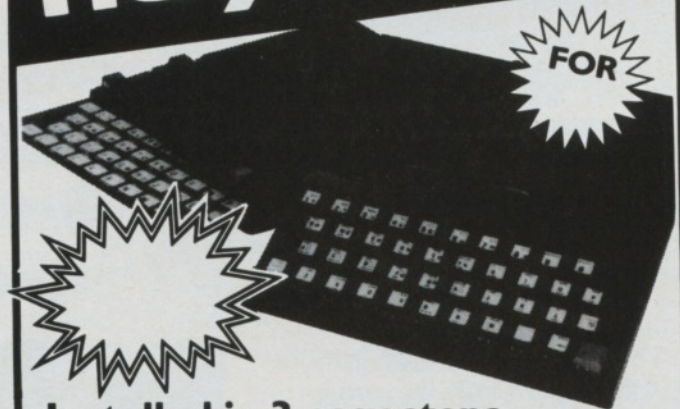

### Installed in 3 easy steps . . .

1. Peel of the touch sensitive key pad.
2. Plug in Klik-Keyboard (no soldering) and place in position.
3. Apply self adhesive two-colour legends to the keys.

This full 40 key keyboard has a positive click feel as the keys are depressed but as it replaces the original touch pad it becomes a permanent part of the ZX81 without bulky boxes or trailing wires.

**KEMPSTON**  
MICRO ELECTRONICS

180a Bedford Road, Kempston, Bedford MK42 8BL ENGLAND

For more information, circle 11 on reader service card.

### LEARN COMPUTER CONTROL APPLICATIONS WITH THE . . .

# Sinclair Expanders

TIMEX 1000, ZX-81 (80)

#### 8-Port IO

Interfaces up to eight  
one-byte ports  
Accepts 16K RAM  
IO \$89

#### ADDA

2-channels A/D, 2-D/A  
Computer sensing and  
control of (analog)  
electrical devices (0-5V)  
ADDA \$89

#### Beeper (Clock / Switch)

Programmable frequency tone generator,  
clock (milliseconds to years) . . .

BCS \$89

Each board comes with educational docu-  
mentation, applications,  
and applications programs  
(1K RAM). \$5 handling  
charge on all orders.

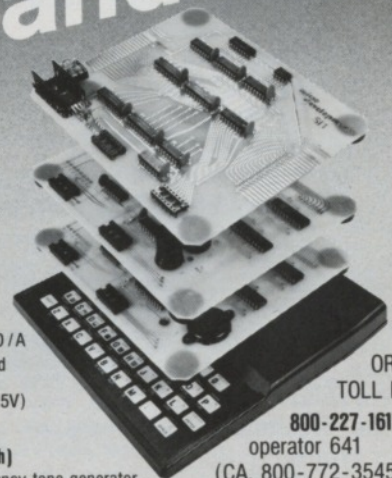

ORDER  
TOLL FREE:

800-227-1617  
operator 641  
(CA, 800-772-3545  
operator 641)

Box 1140  
2000 Center Street  
Berkeley, CA 94704

**micro  
developments**

For more information, circle 13 on reader service card.

TIMEX SINCLAIR USER June 1983



## Rating the Educational Software

	Graphics	Ed. Value	Fun to Use	Work Book	Help in School Work	Program	Money Value	Instructions	Circle Reader Service Card No.
<b>ATOR, THE ABC GATOR (Timex)</b>	9	9	8	No	9	9	Excellent	Good	52
<b>COMPUTER TUTOR (Softsync)</b>	8	6	8	No	6	7	Fair	Good	53
<b>FLASHCARD (International Publishing)</b>	7	7	6	No	7	7	Good	Good	54
<b>MATH SERIES (Reston)</b>	8	9	8	Yes	9	9	Excellent	Good	55
<b>MULTIPLE CHOICE (Mindware)</b>	7	7	6	No	7	7	Good	Good	56

the computer and presented to the learner in one of two ways: randomly with repeats for a set number of cards; or randomly with no repeats, but using all the cards. At the end of either test, your score is presented.

Both Flashcard and Multiple Choice let you put what you want into a good drill, review or test of that information. Neither one teaches, but either could form the basis of good trivia games.

Softsync has a series called Computer Tutor. We looked at two in the series, Math Raiders and Alpha/Vowel Tutor. I would have felt better if the word "tutor" had not been used; it is defined in the dictionary as "teacher," but these programs do not teach. They do tell you if you are right or wrong and they do give you the right answers, but is that really teaching? We don't think so!

In Math Raiders, the game concept has been well used to motivate the child. The student uses his math skills to ward off the landing of an alien form. Each weapon (addition,

subtraction, multiplication, and division) has two levels of difficulty. For fun, these programs rate high. For educational content, they rate low. They include too many different types of problems with too wide a skill range. They lack a logical progression in problem presentation.

Timex's education program Ator, the ABC Gator, is extremely well done. It has eye-catching, high-interest graphics, great pacing and sound . . . that's right, sound in a T/S1000,ZX81 program. You or the child synchronize the tape through a simple but very effective count-down. The child hears original music and great instructions while working the computer. This combination of computer and tape recorder produces a fine educational package.

The one fly-in-the-ointment in this package is the language used on the screen. A child learning the ABC s certainly cannot read the instructions. A notice should be printed on the instruction sheet that an adult or a reader will be

needed to help the child use this program effectively.

Reston Publishing is the first to launch a full-fledged educational math program for the T/S1000,ZX81. It breaks the math lessons into six sets, one for each grade from one to six. In each set there are 32 separate lessons; each introduces a problem, shows how to solve it, then drills and tests the student. They are total lessons based on sound classroom techniques. More important, there is a workbook for each set. After the student does a computer lesson, he or she completes a pencil and paper test of the skill in the workbook. The main drawback to the Reston program is the price. Each set (two cassette tapes, 32 lessons, a 64-page workbook and a vinyl binder storage case) costs \$29.95.

ALL IN ALL, we were really disappointed with the programs that purport to be educational. For the T/S1000,ZX81 we recommend only the Timex and Reston materials.





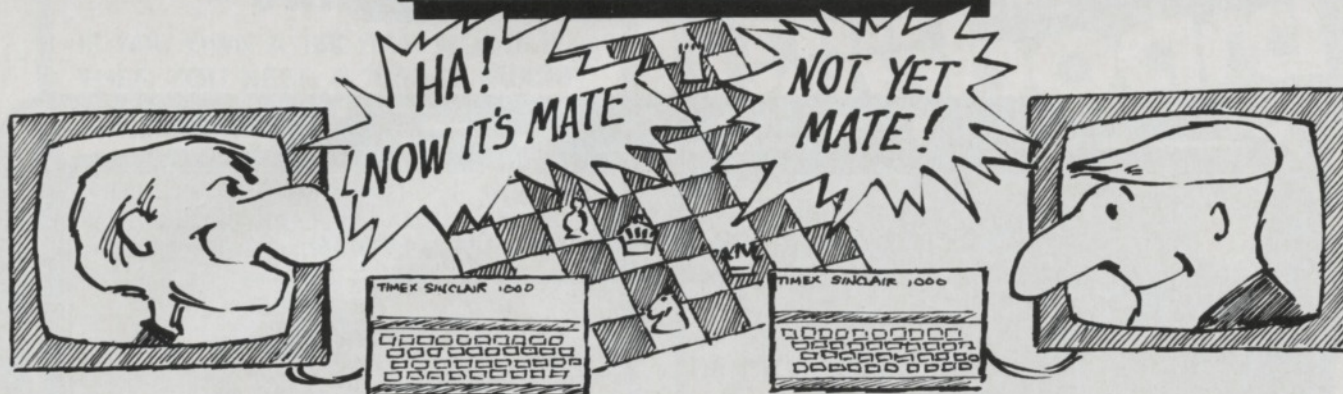

## Check our handy chess guide

In a stalemate over which chess program to buy? Check here before you make your move and you won't get rooked!

**T**O HELP you bring order to the wide array of software available for the T/S1000, ZX81, our writers will look at specific types of programs in each issue. This month we look at six different chess games.

We set up an office tournament which pitted machine against machine, software program against software program, and people against them all. We found that each of these games is a worthwhile purchase; and that, frankly, our game has to improve a bit before we dare rechallenge any of the 16K games. All six use standard algebraic chess notation, but it doesn't matter if you are unfamiliar with this system: only the Timex Sinclair program does not display the notation. 2/2

*You'll notice **★ahem★** that **TimeWare** alone of the **16K** games forbids you to resign and that **Superchess** alone plays against itself **★cough★** 'Game Analysis' by the way, allows you to set up the board for specific problems **★ahem★** Excuse me, I'm a little hoarse **★choke★** It's all these cold knights...*



### PLAYING FEATURES

	recommends moves	allows you to resign	levels of play	game analysis	plays itself	Castles	En passant
Timeware Chess	on levels 2 to 6	NO	6	YES	NO	YES	YES
Chessmaster	on levels 2 to 7	YES	7	YES	NO	YES	YES
Superchess	YES	YES	10	YES	YES	YES	YES
1K Chess	NO	NO	1	NO	NO	NO	NO
2K Chess	NO	NO	1	NO	YES	YES	YES
Timex Sinclair Chess	NO	YES	6	YES	NO	YES	YES



# Focus

## GAME FEATURES

	saves a game	can change sides	can change levels	prints game	screen display rating	memory needed
Timeware Chess	YES	YES	YES	YES	7	16 K
Chessmaster	YES	YES	YES	YES	8	16 K
Superchess	NO	YES	YES	YES	9	16 K
1K Chess	NO	NO	NO	NO	7	1 K
2K Chess	NO	NO	NO	NO	7	2 K
Timex Sinclair Chess	NO	NO	NO	NO	6	16 K



*Psst! Did you know that TimeWare and Chess Master allow you to save unfinished games for later? That Superchess always shows past moves, the others only upon request? That 'Screen display' measures the clarity and usefulness of the displays on a scale of 1 to 10?*

*How about that!*

*'Packaging' measures the 'user-friendliness' of each package on a scale of 1 to 10 too! Care to join me in a coup against the King?*

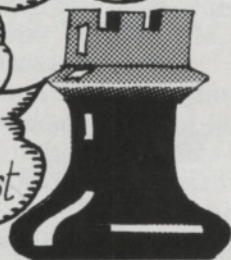

## OVERALL FEATURES

	clarity instructions	enjoyability of game	packaging	speed of response (average)
Timeware Chess	7	9	9	8
Chessmaster	7	9	9	9
Superchess	9	9	7	8
1K Chess	7	6	9	8
2K Chess	7	8	9	8
Timex Sinclair Chess	8	7	9	8

## TIMEX SINCLAIR USER RATING (1-10)

	play	game skill	editor's rating	circle reader service card no.
Timeware Chess	7	8	8	57
Chessmaster	9	9	9	58
Superchess	8	9	9	59
1K Chess	5	5	7	60
2K Chess	6	6	7	61
Timex Sinclair Chess	8	8	7	62

*You'll notice that Chess Master gets the best rating and -- What are those two up there plotting against me now?*





## Go with the flow and no illogical jumps

John Gilbert  
continues  
his course

**L**AST MONTH I explained how to draw a flowchart of a program by splitting it into parts. Each part corresponds to an operation performed either by the user or the computer program. This month we take that a step further and examine a way of breaking a program code into easily-understood areas.

There are three main operations performed in a program — input, processing by the computer, and output. Each of those operations has a distinct box in a flowchart and each has a distinct part in a program. If a beginner is to use the program the input section will be the longest, because of error-trapping techniques and instructions. The processing part of the program will be the longest if a technical person, such as a scientist who knows about computers, uses it.

Now to deal with methods of prompting a user to enter information into the computer and the best ways in which the computer can handle that information. With programs such as the database, which is to be constructed in this series, the screen display is very important. The computer uses the screen to display information to a user.

Many people who use programs such as database or word processors will know nothing about how a computer works or what it expects as input. The more information given to the user by a program the better. That does not mean clogging the screen with vast quantities of text. Instructions on the screen should be easy to read and well-spaced. The clear screen command should be used as often

```
100 DIM B$(100,20)
300 IF A$="1" THEN GOSUB 2000
400 IF A$="2" THEN GOSUB 3000
500 IF A$="3" THEN GOSUB 4000
600 IF A$="4" THEN GOSUB 5000
700 IF A$="5" THEN GOSUB 6000
800 CLS
900 GOTO 200
1000 CLS
1020 PRINT TAB 12;" MENU "
1030 PRINT AT 5,7;"1 SEARCH FILE ";AT 7,7;
      "2 DISPLAY FILE ";AT 9,7;"3 LOAD FILE ";
      AT 11,7;"4 SAVE FILE ";AT 13,7;
      "5 CREATE FILE "
1035 PRINT AT 18,5;" ENTER OPTION (1-5) "
1040 INPUT A$
1050 IF A$="" THEN GOTO 1040
1060 RETURN
```

Listing 1

as possible to break-down information into easily-read pieces but at the same time the jump between one screen of instructions and another should be almost transparent to the user.

The text must flow naturally and there should be no illogical jumps in the instructions. That is a matter of experience but the database has been designed with clarity of instructions and prompts for inputs in mind.

The most important instructions should stand out from the rest. That can be done by liberal use of the GRAPHICS mode.

Listing one is the menu subroutine for the database. One thing people tend to forget is that they have the use of all the screen. Do not cram things into the corners or sides of a screen. Titles should be central and if there is only an INPUT prompt on the screen, a good place to put it is the top left-hand corner.

Listing one is the first module of the program. If there is a menu in a program it should be situated at the top of the code after any single or array variables have been declared, as in line 100 of listing one.

The menu module will display

Listing 2

```
4000 REM LOAD ROUTINE
4010 CLS
4015 PRINT AT 0,0;"NAME FILE TO BE ENTERED "
4018 INPUT C$
4030 IF C$=" " THEN GOTO 4010
4040 PAUSE 10
4042 CLS
4045 PRINT AT 0,0;"SET UP TAPE AND PRESS ENTER"
4050 PAUSE 40000
4060 LOAD C$
4070 PRINT AT 0,0;"FILE LOADED "
4080 PAUSE 100
4090 RETURN
```



# How to program

the options available from the program; ask which you require, put the number of the option selected in a string variable A\$, and transfer to the control program, also in listing one, at the top of the code. The control program, consisting of a series of IF ... THEN instruc-

Listing 3

```

5000 REM SAVE ROUTINE
5005 CLS
5010 PRINT AT 0,0;"ENTER FILE NAME "
5012 INPUT C$
5015 IF C$="" THEN GOTO 5012
5030 PAUSE 10
5032 CLS
5035 PRINT AT 0,0;"SET UP AND PRESS ENTER"
5037 PAUSE 40000
5040 PRINT " FILE """;C$;""" BEING SAVED"
5050 SAVE C$
5060 PRINT " FILE """;C$;""" SAVED"
5070 PAUSE 100
5080 CLS
5090 RETURN
    
```

tions, will then transfer to the subroutine selected from the menu.

The two other modules which are listed in this article are for LOADING data files — listing two — and SAVEing files — listing three.

The displays in both the SAVE and LOAD routines are important. Error messages should be displayed

in the same position on the screen every time they appear. Every program should have a standard error message area to which the user will become accustomed. In the case of the database, that is in the middle of the screen.

The prompts and information in the SAVE and LOAD routines may seem simple and not worthwhile but the writer knows about the internal workings of the program and what to enter. A newcomer to a program, on the other hand, needs to be taken through it step by step.

When a module of a program has been written it is a good idea to test it on a friend or relative who knows nothing about computers. If they can follow the prompts, leave the display as it is; if they are confused, you know you have more writing.

I have now shown how the database is controlled using the menu and how to ease a user's task in getting through the program.

2/2

## WANT TO BUILD YOUR LITTLE TIMEX/SINCLAIR INTO A REAL COMPUTER?

Try our plug-together systems.

MEMORY TO  
1M BYTE  
HI SPEED TAPE  
CHARACTER  
GENERATOR  
TRANSISTOR  
DRIVER  
RELAY DRIVER  
A/D CONVERTER  
FLOPPY DISC  
POWER SUPPLY  
CENTRONICS

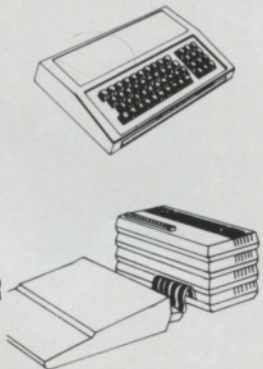

SOFTWARE  
KEYBOARDS  
I/O PORTS  
SWITCHES  
CONTROLS  
JOYSTICKS  
HI RES  
EPROM  
SPEECH  
RS 232  
PRINTERS

Dealer Inquiries Invited.  
Catalog—U.S. Free, \$1.00 Outside U.S.

**Sinclair Place**  
P.O. Box 2288A • Redmond, WA 98052

For more information, circle 14 on Reader Service Card.

## THE TOMB OF DRACULA!



**3D HORROR ADVENTURE GAME!**

FOR THE **16K TS1000/ZX81**

OR **48K TS2000/SPECTRUM**

A superb 3D graphics adventure game! Enter Dracula's tomb at 30 minutes to sunset . . . wander through the tomb's pre-mapped 300 vaults in search of the fabled Vampire's Treasure . . . pick up valuable silver stakes and use them to defend yourself against the lurking horrors . . . ghouls, zombies, pits of primaeval slime . . . See them all on the computer's plan of the tomb . . . when it will let you! Take a chance on a Mystery Vault . . . if you dare! And all the time the minutes are ticking by to sunset . . . when Dracula rises from his coffin and comes after you! Each of the infinite levels of the tomb has its own 300 vaults . . . go as deep as you like, the Prince of Darkness will seek you out in his blood-lust! **WARNING: people of an exceptionally nervous disposition should play this game only during the hours of daylight!** Special facility lets you save a game in progress onto tape so you can continue it whenever you choose.

For TS1000/ZX81 with 16K RAM .....\$14.95

For TS2000/SPECTRUM with 48K RAM.....\$14.95

Price includes ready-to-load cassette with library case and inlay, full instructions, **AIRMAIL** postage and packing. **Order today!** Money refunded if not delighted!

Send cash or cheque to:

**FELIX SOFTWARE (DEPT. SSU1)**

**19 Leighton Avenue, Pinner, HA5 3BW, England.**

For more information, circle 15 on Reader Service Card. 31



# ZEBRA JOYSTICK ADAPTOR

Allows you to connect any Atari compatible joystick to your ZX81 or TS1000.



**6 JOYSTICK GAMES \$9.95**  
**ATARI JOYSTICK \$6.50**  
**ADAPTOR \$19.95**

The ZEBRA Joystick Adaptor comes assembled and tested with simple instructions to make joystick versions of most action games. Use your own Atari compatible joystick or add \$6.50 for a genuine Atari Joystick.

**15 DAY MONEY BACK GUARANTEE**



8 DIRECTIONS  
+ FIRE  
CONTROL

ACCEPTS ANY  
ATARI-COMPATIBLE  
JOYSTICK



EXPANSION  
CONNECTOR FOR  
YOUR MEMORY,  
PRINTER, ETC.

SIMPLY  
PLUG IT  
IN.

ONLY  
**\$19.95**

WITHOUT SPEAKER

**\$24.95**  
WITH SPEAKER

- Add amazing sound effects to your games.
- Easy to program in BASIC.
- Wide frequency range.
- Assembled and tested, with Demo software.

**AMAZING  
SOUND EFFECTS**



**BLIPPO**

PING  
BLEEP  
WHIZ

EXPANSION  
CONNECTOR

SPEAKER  
MODULE

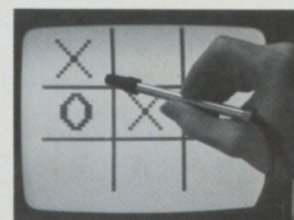

**ZEBRA LIGHT PEN**

- Fun to experiment in BASIC
- Complete package includes:
  - Light Pen
  - Computer Interface Module
  - Demo Program Listings
- Assembled & Tested

ORDER C109 \$24.95

## SUPER GAMES 16K



**3D  
MONSTER  
MAZE**

C113  
\$14.95



**GOBBLE  
MAN**

C114  
\$14.95

## THE BEST BOOKS



C102 BYTING DEEPER INTO YOUR TS1000 ..... \$12.95  
 C103 NOT JUST 30 PROGRAMS FOR THE ZX81 ... \$ 9.95  
 C104 COMPLETE T/S BASIC COURSE ..... \$34.50



C105 UNDERSTANDING YOUR ZX81 ROM ..... \$14.95  
 C106 MACHINE LANGUAGE MADE SIMPLE ..... \$14.95  
 C107 THE INS & OUTS OF THE TS1000 & ZX81 ... \$14.95

## PROTOTYPING? EXPERIMENTING?

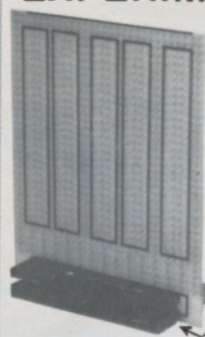

C111  
UNIVERSAL  
PATTERN FOR  
IC'S, CAPS,  
ETC.

C112  
PIGGY BACK  
RAM OR OTHER  
PERIPHERALS

C110  
ALL SIGNALS  
LABELED

C110 Keyed & Labeled ZX Connector \$5.95  
 C111 Universal Prototyping Board .. \$9.95  
 C112 Expansion Connector ..... \$2.50

IMPORTANT! All ZEBRA products can be piggybacked in any order. Your memory, printer, etc. will plug into the last one.

15 DAY MONEY BACK  
GUARANTEE ON ALL  
ZEBRA HARDWARE.

Tech Info & NY State call  
(212) 296-2385 9-5 EST

**Order Toll Free  
800-221-0916**

# ZEBRA SYSTEMS, INC.

78-06 Jamaica Avenue, Woodhaven, New York 11421

Dept. A

For more information, circle 18 on reader service card.

ADD \$3.00 PER ORDER  
FOR SHIPPING  
WE ACCEPT VISA, MASTERCARD,  
CHECKS, M.O.  
C.O.D. ADD \$3.00 EXTRA  
NY RESIDENTS ADD SALES TAX  
OVERSEAS, F.P.O. ADD 10%  
DEALER DISCOUNTS AVAILABLE



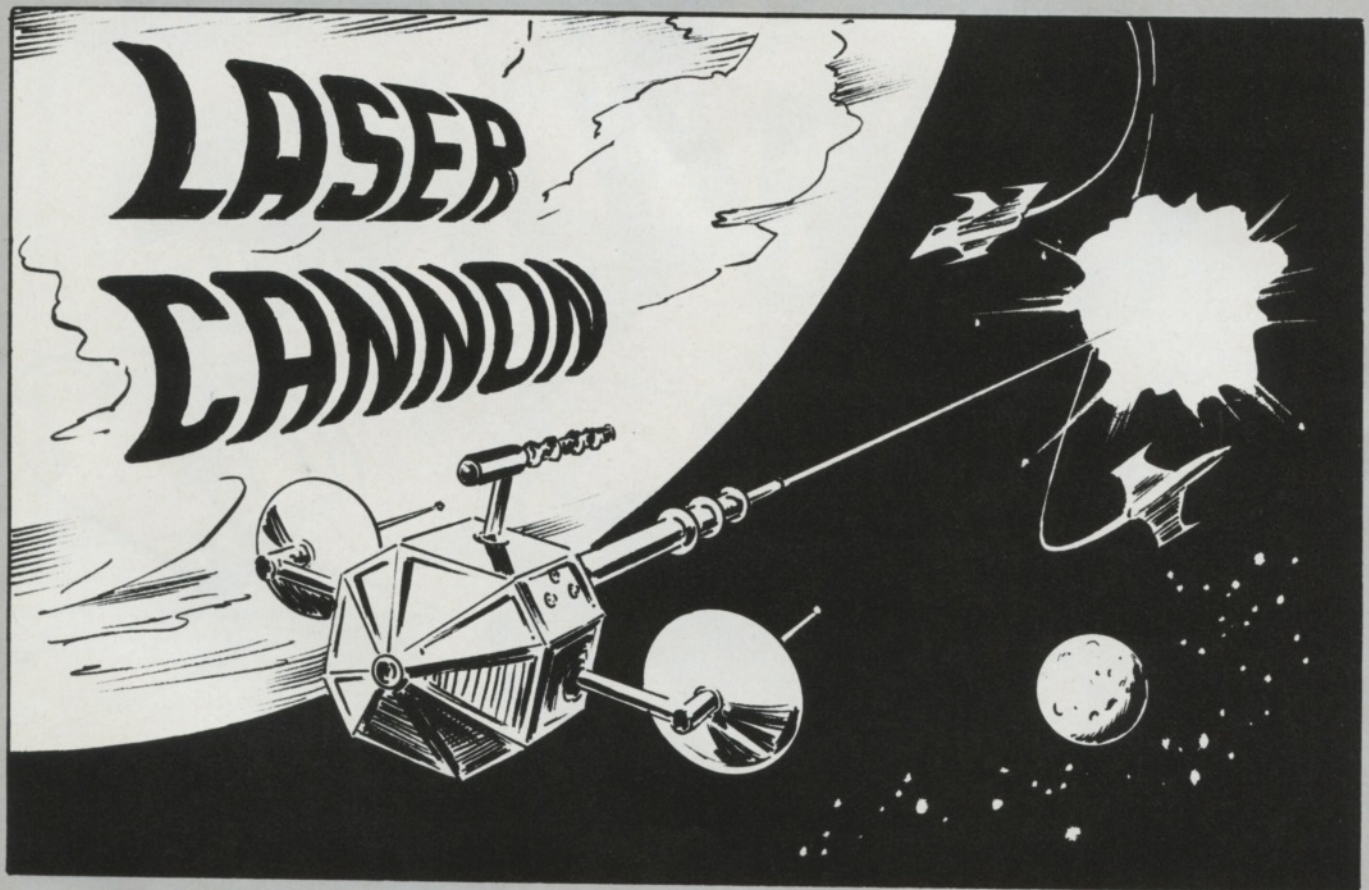

**T**HERE is an over-abundance of **Space Invaders** games, but this one is worth a try because it fits into 1K of memory.

A fleet of 20 "X" ships is attacking you. You must destroy at least 15 of them or be destroyed.

The cursor arrows move you up and down (the shift 5 and shift 7 keys) and the 8 fires your laser cannon. You begin with 200 fuel units and use one every time you move or fire. If you manage to destroy all the "X" ships, the amount of fuel remaining is displayed.

```

10 LET A= 0
20 LET J=200
30 LET K=10
40 LET C=0
50 LET X=INT (RND*18) + 2
60 LET A=A+1
70 IF A=21 THEN GOTO 260
80 LET Y=30
90 PRINT AT K,0;CHR$ 130;CHR$ 128;AT X,Y;"X"
100 IF J < 0 THEN GOTO 150
110 IF INKEY$="7" THEN LET K=K-1
120 IF INKEY$="6" THEN LET K=K+1
130 IF INKEY$="8" THEN PRINT AT K,2;"XXXXXXXXXXXXXXXXXXXX"
140 IF INKEY$="5" THEN LET J=J-1
150 LET Y=Y-1.5
160 IF Y=3 THEN LET C=C+1
170 IF C=5 THEN GOTO 240
180 IF Y=3 THEN GOTO 50
190 IF INKEY$="8" AND K=X AND Y<21 THEN GOTO 220
200 CLS
210 GOTO 90
220 PRINT AT X,Y+1;CHR$ 189
230 GOTO 50
240 PRINT "DESTROYED"
250 STOP
260 PRINT "YOU WIN"
270 PRINT "FUEL LEFT=";J

```



**S**IXTEEN PINS appear at the top of the screen for **Bowling** and the ball at the bottom. Use keys 5 and 8 to line up the two and press key 0 to bowl. The ball will be deflected by impact with the pins and thus make your task more difficult. For every pin hit you will add one to your score; the score is printed after eight balls and the game ends (1K).

# 16 PIN BOWLING

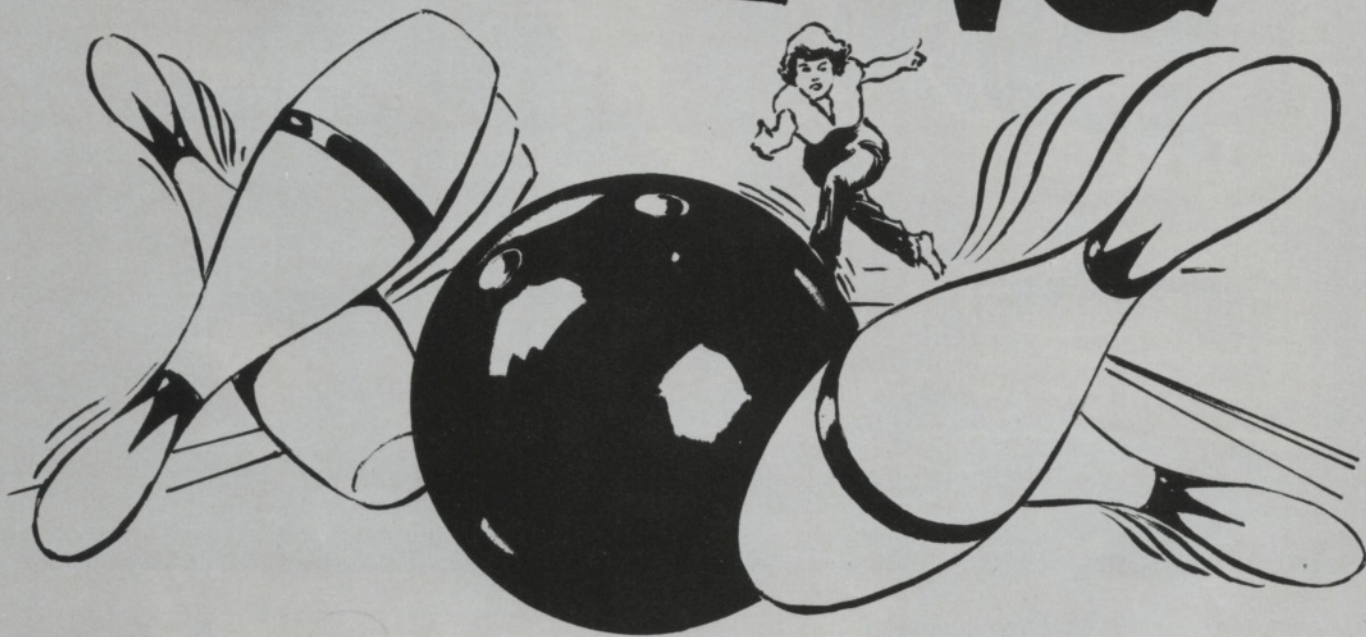

```

1 LET Q=CODE ""
2 LET S=Q
3 LET C=Q
4 LET M=CODE "(graphic 1)"
5 FOR B=M TO CODE "(graphic 4)"
6 FOR A=M+C TO CODE "(graphic E)"-C
7 PRINT AT B,A;"T"
8 NEXT A
9 LET C=C+M
10 NEXT B
11 LET X=CODE "(graphic 7)"
20 LET F=M
25 LET Y=CODE "?"
30 LET X=X + (INKEY#="8" AND X < CODE "(graphic 1)")
  - (INKEY#="5" AND X > CODE "")
35 PRINT AT Y,X; " 0 "
40 IF F > CODE "(graphic E)" THEN GOTO CODE "(inverse -)"
45 IF INKEY#="0" THEN GOSUB CODE "H"
50 GOTO CODE ";"
60 PRINT AT Y,X+M;
65 IF PEEK (PEEK 16398 + VAL "256" * PEEK 16399) = CODE
  "T" THEN LET Q=Q+M
70 PRINT AT Y,X+M; "0";AT Y,X+M; "(inverse 0)";AT Y,X+M;
  ""
75 LET Y=Y-M
80 IF Y=M-M THEN LET F=F+M
90 IF Q > S AND RND < VAL ".5" THEN LET X=X-M
95 IF Q > S AND RND > VAL ".6" THEN LET X=X+M
100 LET S=Q
110 IF Y=M-M THEN RETURN
120 GOTO CODE "H"
150 PRINT Q

```



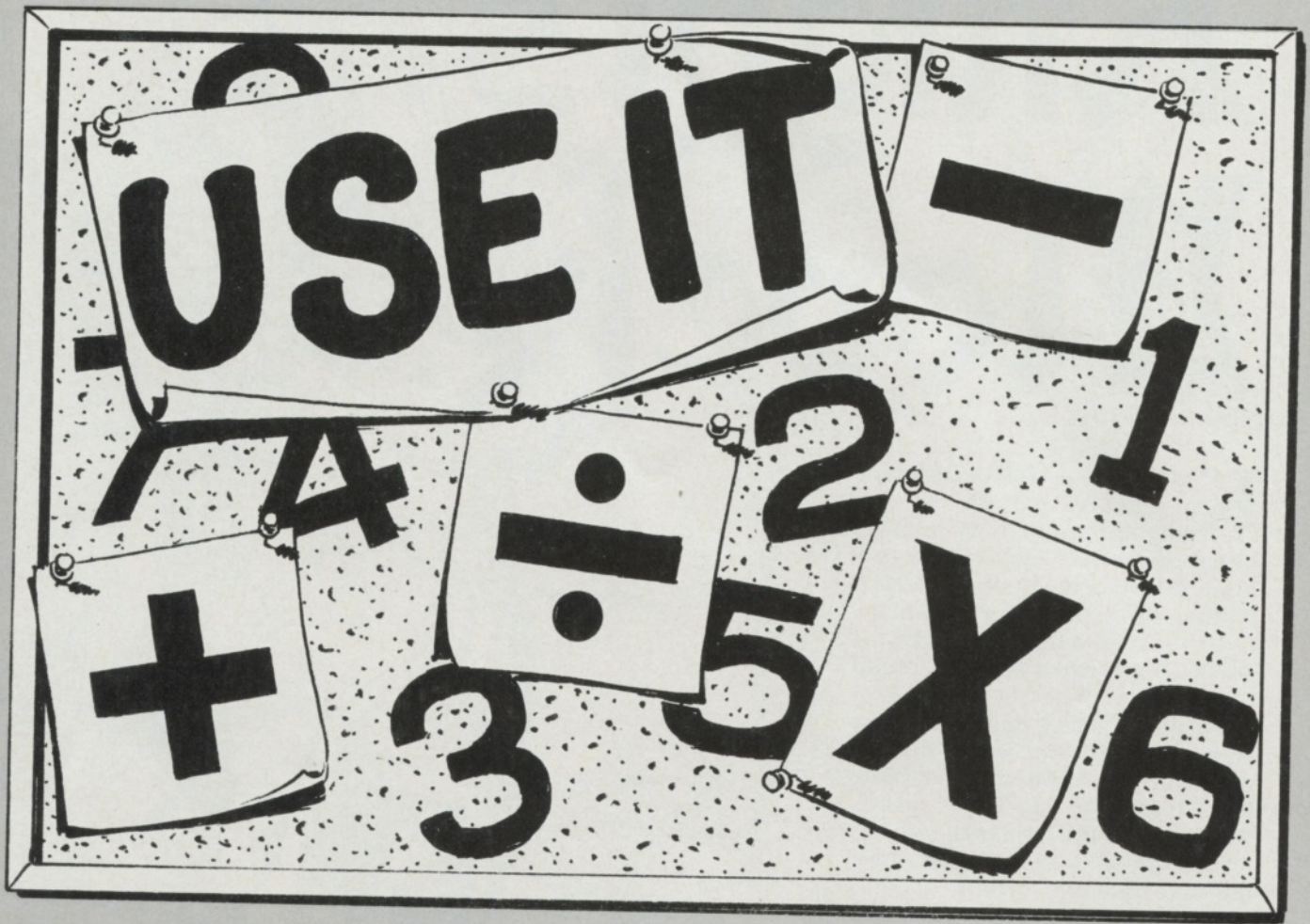

**E**LEVEN-YEAR-OLD Keith Goode of Arlington, Texas, certainly gives you your money's worth with this program. In the menu, **Use It** presents you with, you can choose one of seven op-

tions. The first turns your computer into a drawing board. Option two draws sine wave curves. Three, four, five and six convert your keyboard into a mini-calculator. And finally, just for fun, if you

choose option 7, Keith has your computer show you its entire character set. Thanks, Keith, for showing us what you can make your machine do. (T/S1000,ZX81 16K)

```

10 PRINT "USE IT"
20 PRINT "BY KEITH GOODE"
30 PAUSE 200
40 CLS
50 PRINT "MENU:"
60 PRINT
70 PRINT "1 > PLOTTER"
80 PRINT "2 > SINE WAVE"
90 PRINT "3 > ADD"
100 PRINT "4 > SUBTRACT"
110 PRINT "5 > MULTIPLY"
120 PRINT "6 > DIVIDE"
130 PRINT "7 > CHARACTER LISTING"
140 PRINT "8 > BULLETIN BOARD"
150 PRINT "9 > QUIT"
160 INPUT A$
170 IF A$="1" THEN GOTO 1000
180 IF A$="2" THEN GOTO 2000
190 IF A$="3" THEN GOTO 3000
200 IF A$="4" THEN GOTO 4000
210 IF A$="5" THEN GOTO 5000
220 IF A$="6" THEN GOTO 6000
230 IF A$="7" THEN GOTO 7000
240 IF A$="8" THEN GOTO 8000
250 IF A$="9" THEN GOTO 9000

605 CLS
1000 CLS
1010 INPUT A
1020 INPUT B
1030 PLOT A,B
1040 GOTO 1010
2000 CLS
2010 FOR Z=0 TO 63
2020 PLOT Z,22 + 20 * SIN (Z/32*PI)
2030 NEXT Z
2040 PAUSE 150
2050 CLS
2060 GOTO 50
3000 CLS
3010 INPUT C
3020 INPUT D
3030 PRINT C+D
3040 PAUSE 200
3050 CLS
3060 GOTO 50
4000 CLS
4010 INPUT E
4020 INPUT F
4030 PRINT E-F
4040 PRINT E-F

4050 CLS
4060 GOTO 50
5000 CLS
5010 INPUT G
5020 INPUT H
5030 PRINT G*H
5040 PAUSE 200
5050 CLS
5060 GOTO 50
6000 CLS
6010 INPUT I
6020 INPUT J
6030 PRINT I/J
6040 PAUSE 200
6050 CLS
6060 GOTO 50
7000 CLS
7010 FOR X=0 TO 255
7020 PRINT CHR$ X
7030 NEXT X
7040 CLS
7050 GOTO 50
8000 CLS
8010 INPUT M$
8020 PRINT M$
8030 GOTO 8010

```



# Knight's Move

**K**NIGHT'S MOVE uses the movement pattern of the knight in chess to try to cover every space in a square. The program asks where you wish to start on the board, giving the vertical coordinate first, and then marks the moves as you make your way round the board.

There is a check routine to make sure you cannot cheat by making an incorrect move or land more than once on the same square. When no more squares can be visited, enter 0 as the number for the next square.

Press ENTER to replay the game or any other key and ENTER to end the game.

The graphics in line 20 are the capital I reversed with two reversed dashes (shifted) between each. In line 30 the dashes are replaced by reversed spaces. (T/S1000,ZX81 16K)

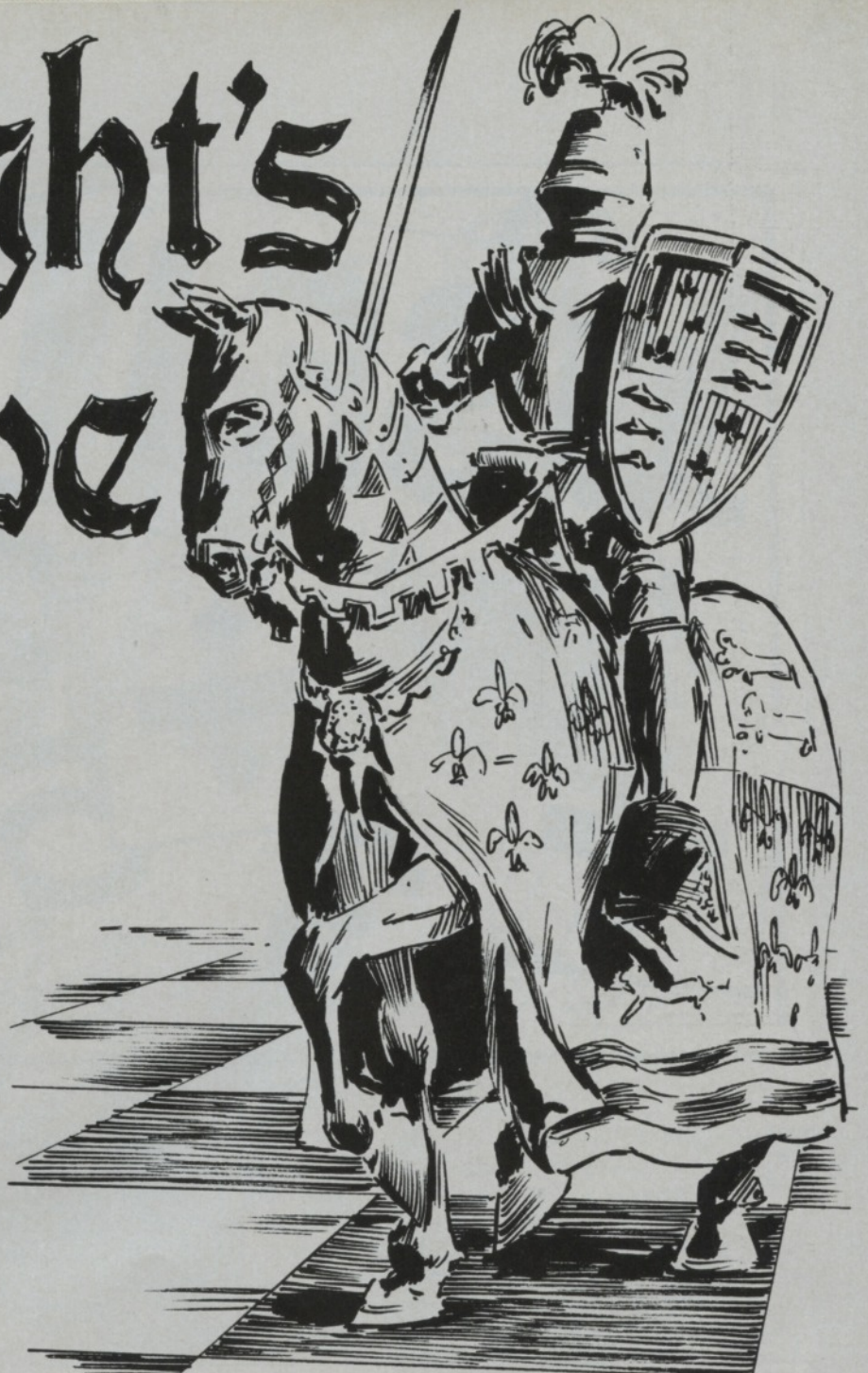

```

1 REM KNIGHT'S MOVE
2 DIM B(8,8)
20 LET A$="I--I--I--I--I--I--I--I--I"
30 LET B$="I--I--I--I--I--I--I--I--I"
40 CLS
50 FAST
60 PRINT TAB 6;"1 2 3 4 5 6 7 8"
70 PRINT TAB 5;A$
80 FOR L=1 TO 8
90 PRINT TAB 3;L;" ";B$;TAB 5;A$
100 NEXT L
110 FOR L=1 TO 8
120 FOR C=1 TO 8
130 LET B(L,C)=0
140 NEXT C
150 NEXT L
160 LET M=0
170 SLOW
180 PRINT AT 20,0;"WHERE DO YOU WISH TO BEGIN"
190 INPUT C#
200 GOSUB 410
210 IF L=9 THEN GOTO 180
220 LET M=M+1
230 PRINT AT L*2,C*3+3;M
240 IF M < 10 THEN PRINT AT L*2,C*3+4;" "
250 LET L1=L
260 LET C1=C
270 LET B(L,C)=1
280 IF M < 64 THEN GOTO 310
290 PRINT AT 20,0;"CONGRATULATIONS"
300 GOTO 490
310 PRINT AT 19,0;" 10 SPACES "
320 PRINT AT 20,0;"WHERE DO YOU WISH TO GO NEXT"
330 INPUT C#
340 IF C#="0" THEN GOTO 490
350 GOSUB 410
360 IF L=9 THEN GOTO 320
370 IF L=L1-2 OR L=L1+2 AND C=C1-1 OR C=C1+1 THEN GOTO 220
380 IF L=L1-1 OR L=L1+1 AND C=C1-2 OR C=C1+2 THEN GOTO 220
390 PRINT AT 19,0;"IMPOSSIBLE"
400 GOTO 320
410 PRINT AT 20,0;" 28 SPACES "
420 IF LEN C# <> 2 THEN GOTO 470
430 LET L=VAL C$(1)
440 LET C=VAL C$(2)
450 IF L<1 OR L>8 OR C<1 OR C>8 THEN GOTO 460
452 IF B(L,C)=1 THEN GOTO 460
454 RETURN
460 LET L=9
470 PRINT AT 19,0;"IMPOSSIBLE"
480 RETURN
490 PRINT AT 21,0;"NL TO REPLAY "
500 INPUT C#
510 IF C#="" THEN GOTO 40

```



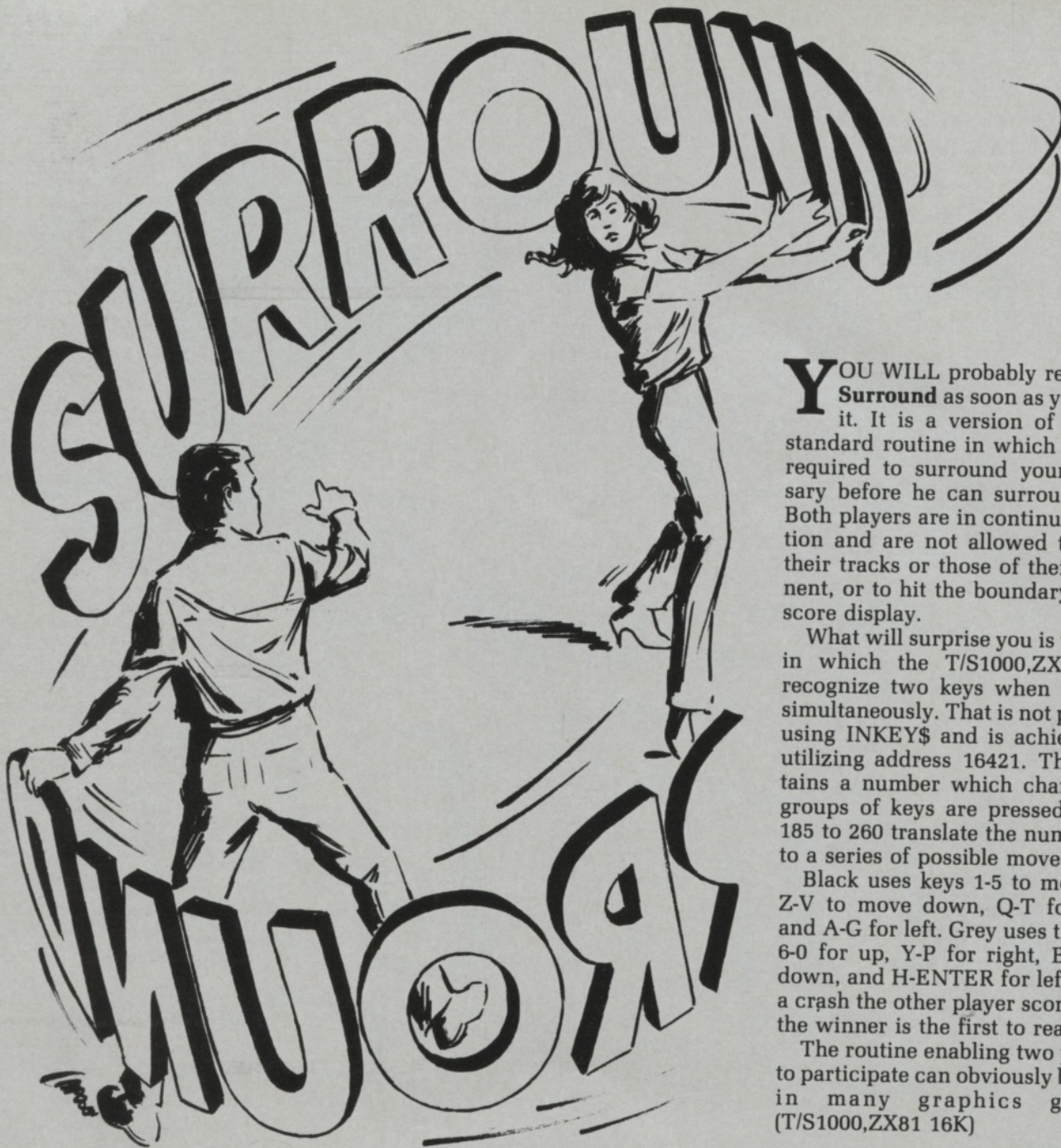

**Y**OU WILL probably recognize **Surround** as soon as you RUN it. It is a version of a fairly standard routine in which you are required to surround your adversary before he can surround you. Both players are in continuous motion and are not allowed to cross their tracks or those of their opponent, or to hit the boundary or the score display.

What will surprise you is the way in which the T/S1000,ZX81 can recognize two keys when pressed simultaneously. That is not possible using INKEY\$ and is achieved by utilizing address 16421. This contains a number which changes as groups of keys are pressed. Lines 185 to 260 translate the number into a series of possible moves.

Black uses keys 1-5 to move up, Z-V to move down, Q-T for right and A-G for left. Grey uses the keys 6-0 for up, Y-P for right, B-M for down, and H-ENTER for left. After a crash the other player scores one; the winner is the first to reach 15.

The routine enabling two players to participate can obviously be used in many graphics games. (T/S1000,ZX81 16K)

```

1 REM SURROUND BY J.WINCHESTER
5 LET SX=0
6 LET SB=0
7 LET O=PEEK 16396+256*PEEK 16397
10 POKE 16418,0
20 PRINT AT 0,0;"*****"
30 FOR P=1 TO 22
40 PRINT "+"
50 NEXT P
60 PRINT ";"*****"
70 PRINT AT 2,2;STR$ SX; AT 2,28;STR$ SB
80 LET X=12
90 LET Y=3
100 LET B=12
110 LET C=28
120 LET X1=0
130 LET Y1=1
140 LET B1=0
145 LET C1=-1
150 IF PEEK (O + 1 + Y + 33 * X) <> 0 THEN GOTO 400
160 IF PEEK (O + 1 + C + 33 * B) <> 0 THEN GOTO 300
170 PRINT AT X,Y;CHR$(128);AT B,C;CHR$(136)
180 LET A=PEEK 16421
185 IF A=238 OR A=222 OR A=190 OR A=254 OR A=126 THEN
LET X1=1
190 IF A=247 OR A=231 OR A=215 OR A=183 OR A=119 THEN
LET X1=-1
200 IF X1 <> 0 THEN LET Y1=0
210 IF A=235 OR A=251 OR A=219 OR A=187 OR A=125 THEN
LET Y1=1
215 IF A=237 OR A=221 OR A=253 OR A=189 OR A=125 THEN
LET Y1=-1
220 IF Y1 <> 0 THEN LET X1=0
230 IF A=231 OR A=239 OR A=235 OR A=237 OR A=238 THEN
LET B1=-1
235 IF A=119 OR A=123 OR A=125 OR A=126 OR A=127 THEN
LET B1=1
240 IF B1 <> 0 THEN LET C1=0
245 IF A=215 OR A=217 OR A=223 OR A=221 OR A=222 THEN
LET C1=1
250 IF A=183 OR A=187 OR A=189 OR A=191 OR A=190 THEN
LET C1=-1
260 IF C1 <> 0 THEN LET B1=0
270 LET X=X+X1
280 LET Y=Y+Y1
290 LET B=B+B1
295 GOTO 150
300 LET SX=SX+1
310 IF SX < 15 THEN GOTO 7
320 STOP
400 LET SB=SB+1
410 IF SB < 15 THEN GOTO 7

```





**A** GAME which links the bug-baiting type of program with a battle against alien invaders has been produced by Sanath Yogasundrum.

When the game begins, the player is asked for a skill level, A or P, which stand for amateur or professional. It is advisable to start on the amateur level while the player begins to understand this complex game.

A small grid is shown in the bottom left-hand corner of the screen in which there are four aliens,

shown as X and \$, with a soldier (\*). The soldier has to dig a hole (O) and then lure the aliens into it, scoring 100 points for every X and 200 for every \$.

The hole is dug by going into dig mode, pressing 2, and pressing the cursor key for which side of the soldier you wish to place the hole. The soldier can then be moved by pressing 01 to return to movement mode, and using the cursors in their normal directions.

A soldier can be killed either by falling into his own hole or being

eaten by an alien. The game lasts for the lives of three soldiers, although an extra soldier can be gained by scoring more than 3,000.

Two other limitations are that only one hole can be dug at a time and a hole cannot be dug beneath an alien. Once an alien has fallen into a hole it is filled immediately and the game continues.

Even after playing for more than an hour at the amateur level, no-one at *Timex Sinclair User* managed to score more than 1,300. (T/S1000,ZX81 16K)



```

1 LET BEST=0
2 PRINT "SKILL LEVEL? (A/P)"
3 INPUT A$
5 CLS
10 LET SO=2
15 LET S=0
20 PRINT """"HOLED UP""""
21 PRINT AT 14,15;"LEVEL:";A$
22 PRINT AT 16,10;"HIGH SCORE: ";BEST
23 PRINT AT 18,0;"          YOUR SCORE:";S
24 PRINT AT 20,0;"          SPARE MEN:";SO
40 LET X=17
50 LET Y=0
60 LET A=17
70 LET B=8
80 LET U=21
90 LET V=4
100 LET G=1
110 LET HX=15
120 LET HY=0
130 LET C=17
140 LET D=4
150 LET E=19
160 LET F=2
165 LET GG=19
170 LET HH=6
195 PRINT AT U,V;"*"
200 PRINT AT X,Y;"$"
210 PRINT AT A,B;"$"
220 PRINT AT C,D;"X"
230 PRINT AT E,F;"X"
240 PRINT AT GG,HH;"X"
300 LET Q=141
305 LET M=X
310 LET N=Y
320 GOSUB 2000
322 LET W=345
325 GOTO 6000
335 LET X=M
340 LET Y=N
345 PRINT AT X,Y;"*"
347 GOSUB 2430
350 LET M=A
360 LET N=B
370 GOSUB 2000
375 LET W=410
380 GOTO 6000
400 LET B=N
405 LET A=M
410 PRINT AT A,B;"$"
415 GOSUB 2430
417 LET Q=189
420 LET M=C
440 LET N=D
460 GOSUB 2000
470 LET W=510
475 GOTO 6000
500 LET D=N
505 LET C=M
510 PRINT AT C,D;"X"
515 GOSUB 2430
520 LET M=E
540 LET N=F
560 GOSUB 2000
570 LET W=610
580 GOTO 6000
600 LET F=N
605 LET E=M
610 PRINT AT E,F;"X"
615 GOSUB 2430
620 LET M=GG
640 LET N=HH
660 GOSUB 2000
670 LET W=710
680 GOTO 6000
700 LET HH=N
705 LET GG=M
710 PRINT AT GG,HH;"X"
720 GOSUB 2430
770 GOTO 300
2003 IF INKEY$="1" THEN LET G=1
2004 IF INKEY$="2" THEN LET G=2
2005 LET R=RND
2010 LET Z=RND
2020 PRINT AT M,N;" "
2090 IF M=18 OR M=20 OR N=V AND A$="P" AND
(N=0 OR N=2 OR N=4 OR N=6 OR N=8) THEN GOTO 2120
2100 IF R <= .5 OR M=U OR N=1 OR N=3 OR N=5 OR N=7
THEN GOTO 2300
2120 IF M=21 OR U<M AND A$="P" THEN LET Z=.7
2122 IF M=17 OR U>M AND A$="P" THEN LET Z=.5
2125 IF Z <= .5 THEN LET M=M+1
2140 IF Z>.5 THEN LET M=M-1
2160 GOTO 2340
2300 IF N=0 OR N<V THEN LET Z=.5
2305 IF N=8 OR N>V THEN LET Z=.7
2310 IF Z <= .5 THEN LET N=N+1
2320 IF Z>.5 AND N>0 THEN LET N=N-1
2340 IF M=U AND N=V THEN GOTO 7000
2400 IF INKEY$="2" THEN LET G=2
2410 IF INKEY$="1" THEN LET G=1
2420 RETURN
2430 IF INKEY$ <> "5" AND INKEY$ <> "6" AND INKEY$ <> "7"
AND INKEY$ <> "8" THEN RETURN
2440 IF G=2 THEN GOTO 2590
2450 PRINT AT U,V;" "
2520 IF INKEY$="5" AND V>0 AND (U=17 OR U=19 OR U=21)
THEN LET V=V-1
2540 IF INKEY$="8" AND V<8 AND (U=17 OR U=19 OR U=21) THEN
LET V=V+1
2560 IF INKEY$="6" AND U<21 AND (V=0 OR V=2 OR V=4 OR V=6
OR V=8) THEN LET U=U+1
2580 IF INKEY$="7" AND U>17 AND (V=0 OR V=2 OR V=4 OR V=6
OR V=8) THEN LET U=U-1
2585 GOTO 3005
2590 PRINT AT HX,HY;" "
2597 IF INKEY$="5" AND V>0 AND (U=21 OR U=19 OR U=17) THEN
GOTO 2700
2600 IF INKEY$="8" AND V<8 AND (U=21 OR U=19 OR U=17) THEN
GOTO 2750
2620 IF INKEY$="6" AND U<21 AND (V=0 OR V=2 OR V=4 OR V=6
OR V=8) THEN GOTO 2800
2640 IF INKEY$="7" AND U>17 AND (V=0 OR V=2 OR V=4 OR V=6
OR V=8) THEN GOTO 2850
2660 GOTO 3005
2700 LET HX=U
2710 LET HY=V-1
2720 GOTO 3000
2750 LET HX=U
2760 LET HY=V+1
2770 GOTO 3000
2800 LET HX=U+1
2810 LET HY=V
2820 GOTO 3000
2850 LET HX=U-1
2860 LET HY=V
3000 IF HX=X AND HY=Y OR HX=A AND HY=B OR HX=C AND HY=D OR
HX=E AND HY=F OR HX=GG AND HY=HH THEN LET HX=15
3003 IF HX <> 15 THEN PRINT AT HX,HY;"0"
3020 IF HX=U AND HY=V OR U=X AND V=Y OR U=A AND V=B OR U=C
AND V=D OR U=E AND V=F OR U=GG AND V=HH THEN GOTO 7000
3030 PRINT AT U,V;"*"
3040 RETURN
6000 IF M=X AND N=Y OR M=A AND N=B OR M=C AND N=D OR M=E
AND N=F OR M=GG AND N=HH THEN GOTO W
6005 IF M=HX AND N=HY THEN GOTO 6020
6010 GOTO W-10
6020 IF Q=141 THEN LET S=S+100
6035 LET S=S+100
6040 PRINT AT M,N;CHR$ Q
6044 IF S/3000 =INT (S/3000) OR
(S-100)/3000=INT((S-100)/3000) THEN LET SO=SO+1
6045 PRINT AT 18,21;S
6047 PRINT AT 20,21;SO
6050 LET HX=15
6060 GOTO W-10
7000 PRINT AT U,V;"*"
7010 LET SO=SO-1
7030 PAUSE 100
7032 IF SO=-1 THEN GOTO 8000
7035 CLS
7040 GOTO 20
8000 FOR N=0 TO 21
8010 SCROLL
8020 NEXT N
8030 IF S>BEST THEN LET BEST=S
8040 PRINT AT 0,0;"GAME OVER, ALL YOUR MEN ARE DEAD"
8050 GOTO 2

```





**T**HE FIRST question often asked about a new machine is "Does it play Space Invaders?" Though a 1K machine has considerable difficulty getting anywhere **Computer Combat** using only 1K, is a type of mini Space Invaders but with only one invader and one base and a much slower rate of firing.

The object of the game is to hit the invader as many times as possible before it lands or you run out of missiles. Twenty-five missiles normally are given but that can be altered by changing the value of B in line 5.

You receive five points for hitting it but lose one if you miss. Use keys 5 and 8 to move left and right respectively and key 0 to fire. The invaders' missiles are shown as asterisks and yours as crosses. The program is good for beginners, as it is easy to understand the function of each line as there are none of the usual POKE and PEEK or other complicated functions.

If you want to get more memory, enter in direct mode the following before entering the program: POKE 16389,68 followed by ENTER NEW followed by ENTER.

The program will run continuously until the BREAK key is used.

Computer Combat was sent in by 15-year-old Anthony Wells. (T/S1000,ZX81 16K)

```

5 LET B=VAL "25"
10 LET S=PI-PI
15 LET M=PI-PI
20 LET X=VAL "16"
25 LET Y=PI-PI
30 LET M=M+2
35 IF M>VAL "20" THEN GOTO VAL "100"
40 CLS
45 LET R=INT (RND*5)
50 IF R=3 THEN GOSUB 155
55 PRINT AT M,Y; "███"
60 LET Y=Y+VAL "2"
65 IF Y=VAL "30" THEN GOTO 25
70 PRINT AT 21,X;"▲"
75 LET X=X+(INKEY#="8")*3-(INKEY#="5")*3
80 IF INKEY#="0" THEN GOSUB 115
85 IF B <= VAL "0" THEN GOTO VAL "100"
95 GOTO VAL "40"
100 PRINT AT 12,10;"SCORE=";S
105 PAUSE VAL "300"
110 RUN
115 PRINT AT M,X;"+"
120 IF X+1 <> Y THEN LET S=S-1
125 IF X+1=Y THEN PRINT AT M,X-1;"***"
130 IF X+1=Y THEN LET S=S+5
135 LET B=B-VAL "1"
140 RETURN
145 PAUSE VAL "50"
150 GOTO VAL "40"
155 PRINT AT 21,Y;CHR# 23
160 IF X=Y THEN GOSUB VAL "170"
165 RETURN
170 PRINT AT 21,Y;"<*>"
175 PAUSE VAL "40"
180 LET S=S-VAL "5"
185 RETURN

```



# Join the CLICK!

Enter your programs Faster & Easier with the E-Z Keyboard . . .

At last, a large 60 key "Tactile Feel" keyboard that plugs into the same connectors as the existing keyboard on your ZX81 or your Timex-Sinclair 1000.



Hear the **CLICK** and feel a **SNAP** for every key pressed! (Tactile Feedback).

Only

# \$84.95



**E-Z Key 60 has the following features:**

- 60 Keys - Legends in 3 colors on the base
- Molded legends on key tops
- 8 Automatic shift keys (no shifting required) for edit, delete, single and double quotes, colon, semi-colon, function and stop.
- 2 Shift keys - **Numeric key pad** - 5" space bar.

**E-Z Key 60** requires no wiring (just plug it in) and can be adapted to fit the XZ80 or the MicroAce (8 KROM). The Mounting base measures 10"x4". Cables and instructions are included.

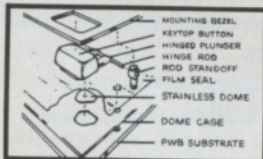

**SWITCH SPECIFICATIONS:**

Key tops measure .4" x .3" - spaced at 3/8" intervals between keys. Life = 10 million operations, typical. Force = 3. oz. Travel = .040". Dome switch, button type with arm to give .040" travel.

A custom made enclosure (shown above) is also available for your computer and E-Z Key 60 keyboard.

Measurements:	Price:
EC-11 11"x9"x3" .....	\$25.00
EC-14 14"x9"x3" .....	\$30.00

*WATCH FOR THESE NEW PRODUCTS!*

**JOYSTICK:** Joystick kit that requires no wiring and will function like the arrow keys & Ø on your computer.

**E-Z Key 40** Replacement flat keyboard with embossing around each switch and 3 color legends and graphics as existing keyboard (plug in replacement).

90 day warranty

## E-Z KEY

**SUITE 75 A, 711 SOUTHERN ARTERY  
QUINCY, MASSACHUSETTS 02169  
(617) 773-1187**

**USE THIS ORDER FORM...**

<input type="checkbox"/> Check or Money Order	E-Z Key 60	Quantity	Unit Price	Total
	EC-11/14		\$84.95	
Charge to my:			\$25/\$30	
<input type="checkbox"/> Visa <input type="checkbox"/> Mastercard		Total units S&H \$4 per unit		
Card # _____		Mass, res. add 5% sales tax		
Expires _____		Total		

Send to: **E-Z KEY**  
Suite 75 A  
711 Southern Artery  
Quincy, MA 02169

Signature \_\_\_\_\_  
Name \_\_\_\_\_  
Address \_\_\_\_\_  
City \_\_\_\_\_ State \_\_\_\_\_ Zip \_\_\_\_\_



## Who says that graphics

All you need to start is a simple understanding of the PLOT command, says professor and author Michael K. Barnett in this exclusive interview

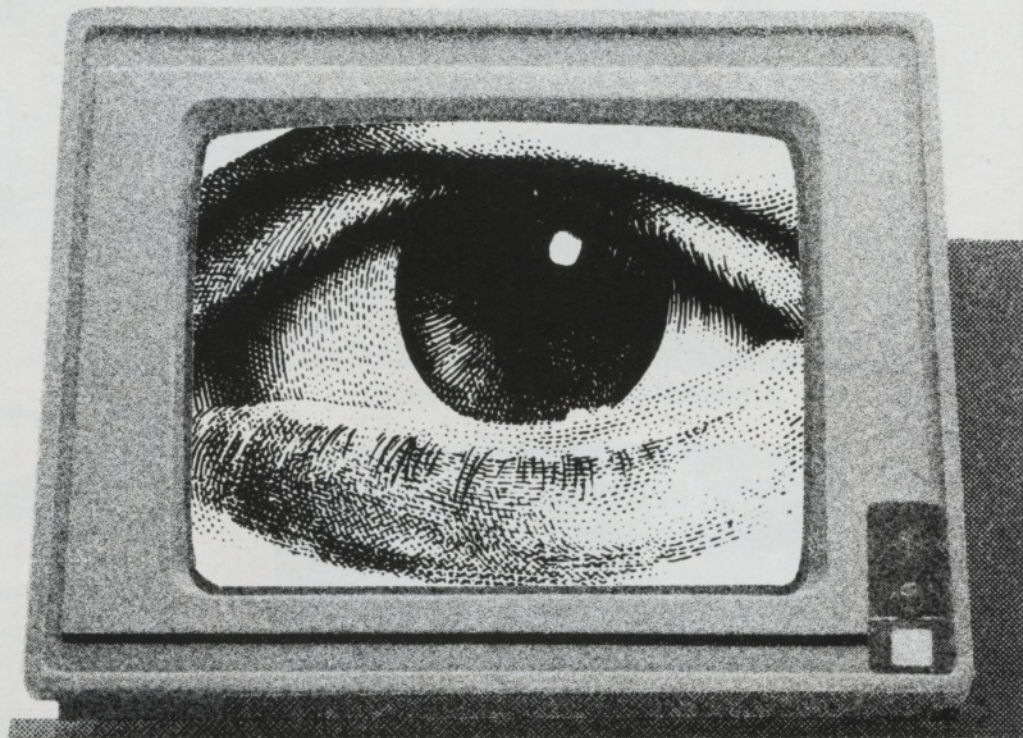

Can you tell us some of the computers that you use for computer graphics?

These include some very large IBM machines like 370s, 3033s and 3081s, some personal computers like the Apple, and the Timex Sinclair 1000 home computer.

Does it make sense to use a T/S1000, ZX81 when you can use these larger machines?

Yes — a lot of sense. The T/S1000 and the large IBM machines are at opposite ends of what many people see as a unified scheme — for teaching and learning what computer graphics can be used to convey.

What are the limitations of T/S1000 graphics and how do they affect the fields where T/S graphics will be used?

The limitations are the resolution that it can provide on the television

screen, the amount of data that can be stored for reference, and the speed at which it calculates. However, I don't see these locking the T/S1000 out of particular fields where graphics are useful; within these fields, the Timex will be used where low resolution is adequate, perhaps as a preliminary to using higher quality equipment.

Where do you think Timex graphics will be used?

Education, business, research and engineering, and entertainment, for a start.

How will it be used in education?

Initially, to teach programming and computer literacy, to help teach math, to teach people how to use computer graphics in their work; as time goes on, in chemistry and other sciences, in social sciences and in educational administration.

How can it be used to teach programming?

Many people are afraid of computers because they are afraid of mathematics and formulas. And most people do not have ready access to a computer, or the money to spend on a terminal and phone bills. You can buy a T/S1000 for the price of a couple of textbooks or a home appliance, and work with it in your own time and at your own pace in the comfort and privacy of your home. And the graphics let you start using commands based on the simple idea of using squared paper that people see around the house in patterns for knitting and laying tiles and so on.

You mean someone can get started just using the PLOT command?

Sure. After PLOTting a few points in the immediate mode to get a feel for the numbering, you can write simple programs with FOR loops to draw straight lines and



## have to be complicated?

make them move. For example, just type

```
10 FOR X = 10 TO 50
20 PLOT X,20
30 NEXT X
```

and you get a horizontal line about halfway down the screen. Change the numbers in the FOR statement, keeping between 0 and 63, and this changes the length of the line. Change the Y value in the PLOT statement from 20 to any other value between 0 and 43 and you change the height of the line. And to get a vertical line, you put Y in the FOR statement instead of X, and you change the PLOT statement to PLOT 20,Y to draw the line roughly halfway across the screen.

What about sloping lines?

Easy. Try

```
10 FOR N = 0 TO 40
20 PLOT N,N
30 NEXT N
```

That slopes up from southwest to northeast.

And to get it to slope up from southeast to northwest?

Try

```
10 FOR N = 0 TO 40
20 PLOT 63-N,N
30 NEXT N
```

You can build lots of patterns using these tactics. Here is a simple example.

How many lines of code did this take?

This does it in 20 lines:



## T/S1000 graphics can be used anywhere low resolution is adequate

```
10 FOR K=1 TO 4
20 FOR X=32-2**K TO 32+2**K
30 PLOT X,21-2**K
40 PLOT X,21+2**K
50 NEXT K
60 FOR Y=22-2**K TO 20+2**K
70 PLOT 32-2**K,Y
80 PLOT 32+2**K,Y
90 NEXT Y
100 FOR X=33-2**K TO 31
110 PLOT X,X-11+2**K
120 PLOT X,53-X-2**K
130 NEXT X
140 FOR X=33 TO 32+2**K
150 PLOT X,53-X+2**K
160 PLOT X,X-11-2**K
170 NEXT X
180 NEXT K
190 POKE 16417,1
200 COPY
```

Perhaps your readers can shorten this or speed it up, for example by calculating  $2^{**}K$  just once in each cycle.

We'll ask them. Timex graphics certainly let people learn about coordinates and FOR loops very quickly.

Yes. And about interactive design.

I thought that needed very expensive equipment. Isn't it the sort of thing that car manufacturers do?

Try the following program. It won't let you design a car, but it does illustrate the basic tactic of interactive design.

```
10 LET B$ = " "
20 LET B$ = B$ + B$ + B$ + B$
30 PRINT AT 0,0; "XLO,XHI,Y: ";
```

```
40 INPUT XLO
50 INPUT XHI
60 INPUT Y
70 PRINT XLO; " "; XHI; " "; Y
80 FOR X = XLO TO XHI
90 PLOT X,Y
100 NEXT X
110 IF INKEY$ <> "" THEN
    GOTO 110
120 PRINT AT 1,0; "PRESS K TO
    KEEP, E TO ERASE: ";
130 IF INKEY$ = "" THEN GOTO
    130
140 LET R$ = INKEY$
150 PRINT R$
160 GOTO 300*(R$ = "K") + 200*
    (R$ = "E")
170 PRINT AT 1,0; B$
180 GOTO 110
200 FOR X = XLO TO XHI
210 UNPLOT X,Y
220 NEXT X
300 PRINT AT 0,0; B$; B$
310 GOTO 30
```

Statement 30 prompts for the values of X at the ends of the line you want the program to draw, and for the value of Y. Statements 80 to 100 draw the line. Statement 110

## You can learn basic principles of animation on your T/S1000,ZX81

waits if you still are pressing any keys. Statement 120 prompts you to show whether you want to keep the line or to change your mind — this is what makes it interactive. Statements 200 to 220 erase the line if you request this. Then the cycle begins all over again.

And I can use the same principle to expand the program, to prompt the user to type, say, D for a dot. H for a horizontal line and V for a ver-



# Hints & tips

tical line, followed by the coordinates . . .

Correct. The person learning can take off very quickly, varying and expanding the prototype programs for graphics.

*Do these principles of graphics apply to larger machines?*

Yes. Using the T/S1000, students and architects and fashion designers and planners can get a handle on writing prompting sequences at home. Then if they want larger or higher quality graphics, they can go to bigger machines and program these themselves or tell the programmers what to do.

*Can you get animation effects on the T/S1000?*

Yes. For example, patterns move

**“We vastly under-utilize the resources at our disposal”**

up the screen by SCROLLing. To see this, just type:

```
10 FOR N = 0 TO 63
20 SCROLL
30 PRINT TAB N; " "
40 NEXT N
50 GOTO 10
```

This seems to make lines of little darts shoot up.

*I suppose if you turned the screen on its side you could get things to SCROLL sideways.*

I would not recommend that with the family television set.

*What if you want to draw a face with an eye that opens and shuts, or a caterpillar wriggling across the screen?*

Easy. Many of the programs in my recent book *Personal Graphics for Profit and Pleasure on the Apple II Plus Computer* (with Graham K. Barnett; Little, Brown; \$14.50) can be adapted to the T/S1000,ZX81. “Winkface” draws a face and makes one eye wink. The outline of the eye is drawn first: on the Timex

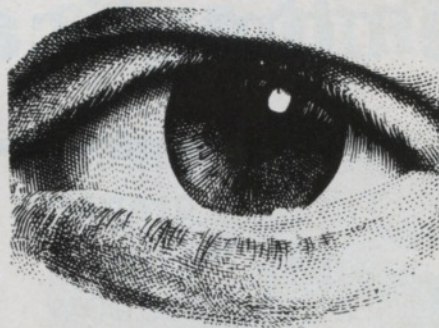

you just use PLOT commands. Then if the center of the eye is at position XC,YC you make it blink by statements like

```
500 PLOT XC,YC
510 PAUSE 60
520 UNPLOT XC,YC
530 PAUSE 60
540 GOTO 500
```

This use of PLOT to draw and UNPLOT to erase, or its equivalent in other programming languages, is a basic tactic of animation. Try this ten-liner and meet Grenville the Graceful Grub:

```
10 FOR N=0 TO 7 STEP 2
20 PLOT N,20
30 PLOT N+1,21
40 NEXT N
50 FOR M=0 TO 54 STEP 2
60 UNPLOT M,20
70 PLOT M+8,20
80 UNPLOT M+1,21
90 PLOT M+9,21
100 NEXT M
```

He wiggles across the screen from left to right. And you can vary the program easily to make grubs of different lengths and shapes wiggle in different directions.

Here is a very different type of graphics demonstration — a very simple bar chart program:

```
10 LET B$="
"
20 PRINT AT 0,0;"MAXIMUM
VALUE: ";
30 INPUT MAXIMUM VALUE
40 PRINT MAXIMUM VALUE
50 LET Y=43
55 PAUSE 60
60 PRINT AT 0,0;B$;AT 0,0;"CAP-
TION,VALUE: ";
```

```
70 INPUT C$
80 INPUT VALUE
90 PRINT C$;" ";VALUE
100 LET Y=Y-2
110 IF Y<=0 OR VALUE>MAX-
IMUM VALUE THEN GOTO
1000
120 LET R=INT (.5+50*VALUE
/MAXIMUM VALUE)
130 FOR X=1 TO R
140 PLOT X,Y
150 NEXT X
160 IF LEN C$>30-R/2 THEN
LET C$=C$( TO 30-R/2)
170 PRINT " ";C$;"("";VALUE;")"
180 GOTO 60
1000 POKE 16417,1
1010 PRINT AT 0,0;B$
1020 COPY
```

It prompts for the maximum value to be represented horizontally. Then it prompts for the captions of the bars and the values these represent. It draws and labels the bars and, when you want to quit, you just press ENTER, type a number greater than the maximum value you typed originally, and press ENTER again. Here is an example of its output:

```
█ FISH(15)
█ MEAT(10)
█ MILK(20)
█ EGGS(25)
█ FRUIT(10)
█ OTHER(20)
```

*Most of the examples you have given are charts and geometrical shapes and patterns. Don't you feel hampered by the lack of pictorial realism?*

I look on it rather as a challenge to find what can be conveyed without so-called realism. I think that a very sad aspect of high technology in general is that we vastly under-utilize the hardware, software, mathematics and very sophisticated techniques at our disposal. Part of the problem is that we haven't learned how to make the most of simple resources.

*Do you think the smallness of machines like the T/S1000 will stimulate new research?*

Yes.





# THE MINDWARE LINE OF SOFTWARE FOR TIMEX/SINCLAIR COMPUTERS

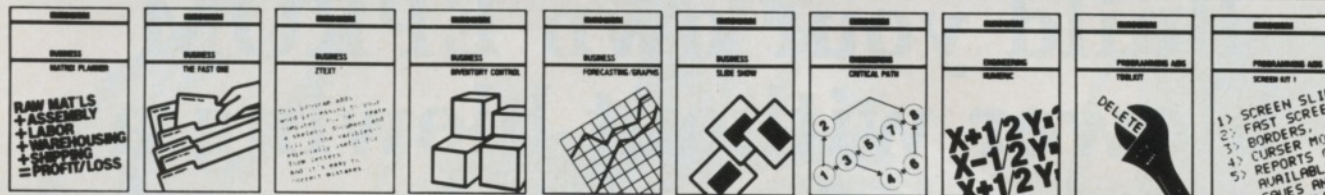

**MATRIX PLANNER**  
An all-purpose electronic spreadsheet.  
**\$22.95**

**THE FAST ONE**  
Store, organize and retrieve data instantly.  
**\$24.95**

**Z-TEXT**  
A useful word processing program.  
**\$19.95**

**INVENTORY CONTROL**  
Two ways to keep track of inventories.  
**\$22.95**

**FORECASTING GRAPHS**  
Analyzes growth trends and plots graphs.  
**\$22.95**

**SLIDE SHOW**  
Creates and runs video display shows.  
**\$22.95**

**CRITICAL PATH**  
Gets complex scheduling under control.  
**\$19.95**

**NUMERIC**  
Solves math formulas and draws graphs.  
**\$24.95**

**TOOLKIT**  
Shortcut commands for programmers.  
**\$19.95**

**SCREEN KIT**  
Routines to enhance screen displays.  
**\$19.95**

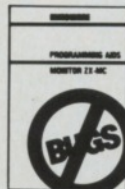

**MONITOR**  
Tests and debugs programs in machine code.  
**\$19.95**

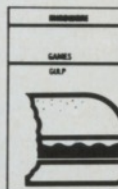

**GULP**  
Gobble your way through mazes, chased by ogres.  
**\$15.95**

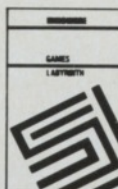

**LABYRINTH**  
Can you find your way through 3-D corridors?  
**\$15.95**

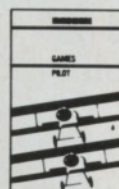

**PILOT**  
Cockpit controls that teach you how to navigate.  
**\$19.95**

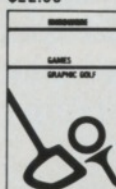

**GRAPHIC GOLF**  
A challenging 18-hole golf course.  
**\$9.95**

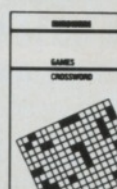

**CROSSWORD**  
Create and play your own crosswords.  
**\$15.95**

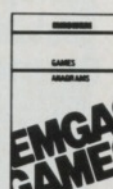

**ANAGRAMS**  
Try to put the scrambled words back in order.  
**\$15.95**

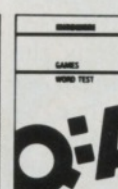

**WORD TEST**  
All kinds of question and answer tests.  
**\$15.95**

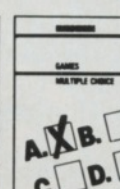

**MULTIPLE CHOICE**  
Can you pick the correct answer?  
**\$15.95**

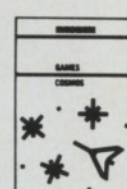

**COSMOS**  
Hyperspace laser battles among the stars!  
**\$15.95**

- FAST LOADING** Mindware's proprietary Quickload™ feature lets you load programs up to four times faster than conventional Timex/Sinclair programs. Quickload software also alerts you to misloads, and lets you restart the tape from the point of interruption, without re-loading from the beginning.

- QUALITY TITLES** Mindware software is written by top British software developers, including Picturesque, Hewson, Hilderbay, Asher, Campbell, Axis, Jones, Vortex and Silversoft.

- USER-FRIENDLY** Documentation provides clear instructions, learning examples, and trouble-shooting tips. (All programs require 16K.)

## THE ONLY PLAIN PAPER, DOT-MATRIX PRINTER FOR THE TIMEX/SINCLAIR SYSTEM



Mindware's MW-100 gives you the ability to make hard copies of programs, data, mailing lists, and screen graphics.

**SPECIAL OFFER:** Order a MW-100 printer for \$119.00 and get your choice of any two Mindware software titles **FREE**; plus **5 FREE** rolls of paper (comparable retail value, \$150-182.00). Thousands of MW-100's have sold nationally at a retail price of \$129.95 (Printer alone).

SOFTWARE ORDER	
Title	Price
Postage & handling	2.25
Total	
(Mass.residents add 5% tax)	
<b>SPECIAL PRINTER OFFER - Retail value, \$150-182.00</b>	
MW-100 printer -	119.00
Two software titles free:	N/C
	N/C
Postage & handling	4.95
Total	
(Mass. residents add 5% tax)	
Total _____ enclosed is <input type="checkbox"/> check <input type="checkbox"/> money order	
Charge to <input type="checkbox"/> Visa <input type="checkbox"/> Mastercard	
Number _____	Volume discounts available to dealers and schools.
Expiry _____ Signature _____	
Please Print	
Name _____	Send more info on:
Address _____	<input type="checkbox"/> Quickload software.
City/State/Zip _____	<input type="checkbox"/> MW-100 printer.

**SEND TO: Eagle Sales Co./TS**  
15 Tech Circle Natick, MA 01760  
(617) 655-3368

For more information, circle 16 on reader service card.



# Build your own EPROM blower without blowing a fortune

**B**ECAUSE most users of the T/S1000, ZX81 are software-orientated, the hardware has been made simple in this design. The software needed to run it consequently will be large and some of it is in machine code.

The heart of the design is the 8255 programmable peripheral interface device. This chip has 24 lines of input or output, which can be defined by software. There are only sufficient to handle the 2532 EPROM. Port A is used to output the eight least significant bits and port C for the remaining address bits and control bits. Table one shows which functions port C has for each of the two types of EPROM. The design caters for the 2516 and 2432 EPROMs from Texas Instruments. The 50ms programming pulse is timed by the hardware and PC4 output must return to 0 before 50ms has gone by.

A simple program is included to enable the programming of the EPROM. The machine code routine in the first REM statement will program one memory location and read that memory location. The Basic will call the routine as required. The reason machine code is required is because the 8255 chip is placed in the I/O map of the Z-80 so that the memory map is left alone. In the T/S1000, ZX81 the PEEK and POKE commands access only the memory map. As Sinclair has not fully decoded the I/O map it was difficult finding somewhere where the 8255 was not affected by the T/S1000, ZX81.

Another reason for leaving the memory map alone is so that EPROMs can be placed above the 8K ROM. These could contain routines to improve the 8K Basic. Anyone building it is also advised to acquire a data sheet on the 8255, as the chip is very complex.

Stephen Churchman details how to expand the storage available for programs using inexpensive components

Referring to the circuit diagrams, two Nand gates have been used and three Or gates to drive the chip select pin. CS will go low only when A0, A1, A2, A3 are logic 1 and A7, IORQ are logic 0. That places the 8255 at 1FH, 3FH, 5FH, and 7FH. The other two Nand gates ensure that the 8255 and 50ms timer are re-set when power is applied.

The only difference between the 2516 and 2532 EPROMs are two pins and that is why a switch has been included. When programming the 2532, the programming voltage must be switched from 5V to 26V and back to 5V either side of the programming pulse. With the 2516 it may be left at 26V to verify the

EPROM contents. The 26V regulator can be switched to 5V by the PC7 output going high, switching-on the BC108 and placing a 5V zener across the 24V zener.

The power supply is standard, using a single transformer and half-wave rectification for the 5V supply and voltage doubling for the 26V supply. It is best to make sure that the transformer you buy has two 9V windings in series aiding. The 50ms timer uses a 74123 TTL chip — only one half is being used. The diode And gate is needed as pin 20 of a 2532 needs to be low when reading (C5) and low for 50ms when programming.

The prototype is constructed on two pieces of Veroboard: the PSU on 0.15in. matrix and the main components on a piece of VQ board. It is wired with Verowire, which is ideal for a prototype, as modifications are easy to implement. The final board is somewhat cluttered because an extra chip had to be added at a later stage to help with the decoding of the CS line. The transformer is bolted to the base of the case and a cassette-type mains plug and socket on the case.

The power transistor (BD235)

Figure 1: Driver circuit

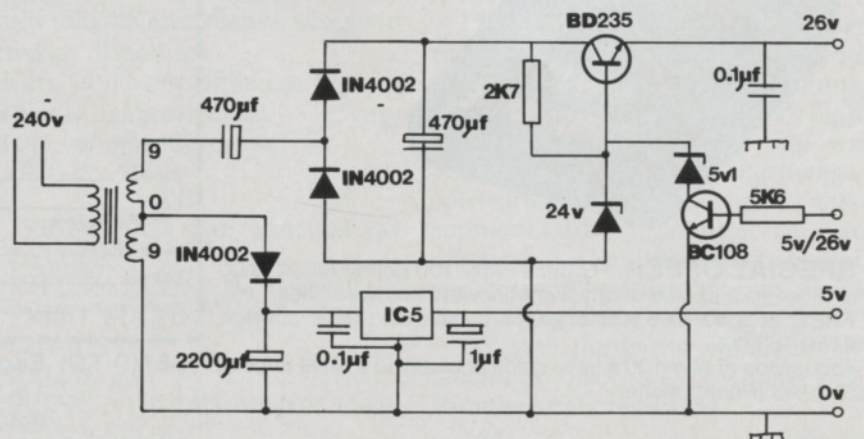



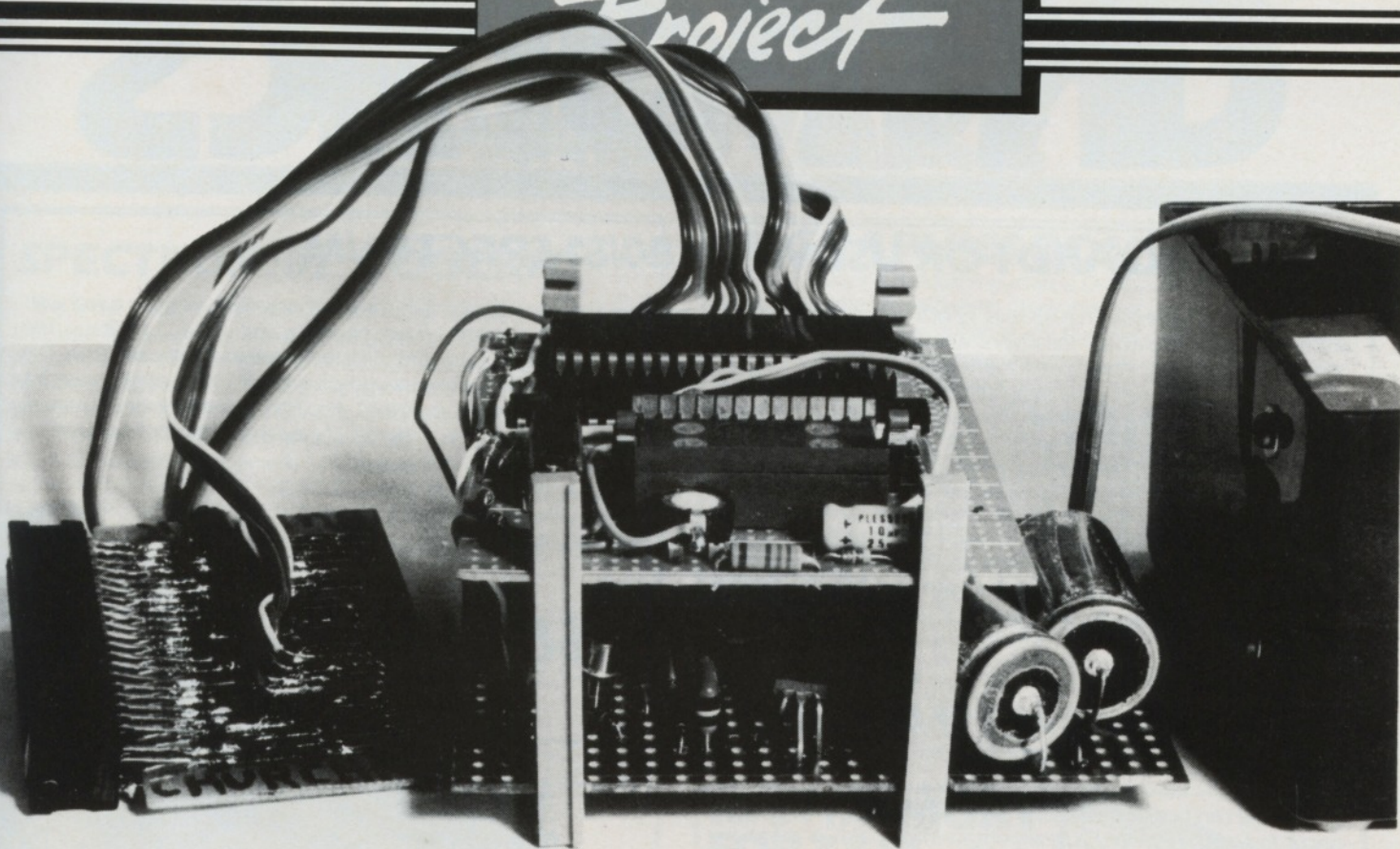

Figure 2: EPROM blower outside its case

Figure 3: P.S.U. diagram

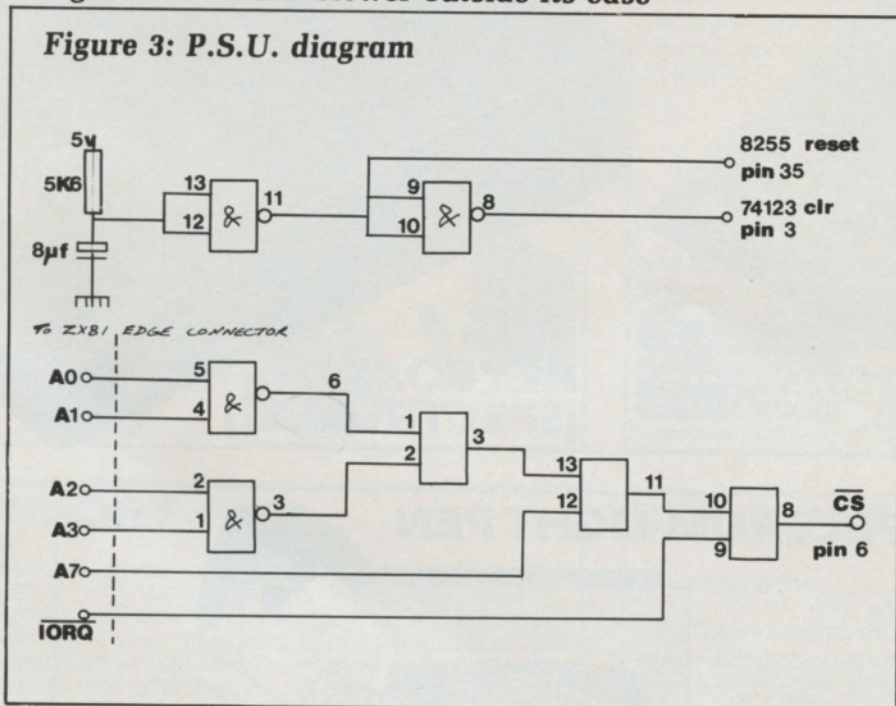
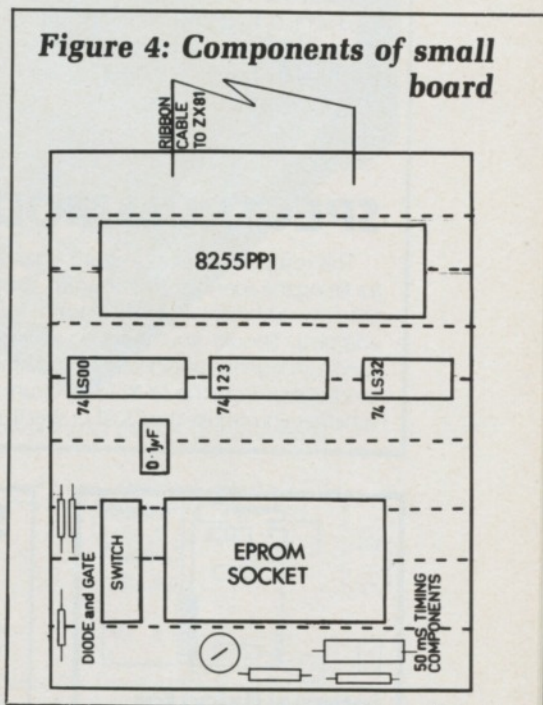

Figure 4: Components of small board



and voltage regulator do not need heat-sinks as they pass fairly small currents. The two boards are fixed on top of each other, with the EPROM socket emerging through a hole in the top cover of the box. The switch is mounted next to the EPROM socket.

With a REM statement on the first line of a program, the first character is at memory location 16514 decimal. The first four locations are used to hold data for the machine code program, the machine code sub-routine starting at 16518.

16514 — BYTE FOR PORT B  
 16515 — BYTE FOR PORT C  
 16516 — BYTE FOR PORT A  
 16517 — READ FROM PORT A — used for verification.

Within the program, register H holds the byte for Port C, and



# D.K. Electronics

## ZX KEYBOARD FOR USE WITH 80/81 SPECTRUM

Our new cased keyboard has 52 keys, 12 of these are used for the numeric pad. The numeric pad offers some useful features, you can cursor with one hand and it will be a boon for anyone who enters a lot of numeric data. The pad is a repeat of the 1-9 keys plus it has a full stop and a shift key. The numeric pad keys are coloured in red, the normal keyboard keys are grey, with the case being black which makes the whole thing very attractive. The case measures 15 x 9 x 2½. The computer (either 80/81 or spectrum) fits neatly inside. You will have to remove the computer from its original case, it is then screwed to the base of the case. The case had all the bosses already fitted and the screw holes are marked. Also fitted inside the case is a mother board (81 model only) which allows 16K, 32K and 64K to be fitted in the case. All the connections are at the rear of the case i.e. Power, Mic, Ear, T.V. and the expansion port. The case is large enough for other add ons also to be fitted inside. One of these could be the power supply, then you could very quickly fit a mains switch, or a switch on the 9V line. This means you have a very smart self-contained unit. This case does not stop you from using any other add-ons that you may have e.g. Printer etc. We are convinced that this is the best keyboard available at present. It offers more keys and features than any other keyboard in its price range.

**\$81.00**

### NOTE

The case can be purchased separately with the keyboard aperture uncut, so if you have one of our early uncased keyboards, or in fact any other suppliers' keyboards, these could be fitted. The keyboard is connected to your computer by a ribbon cable and this has connectors fitted which simply push into the Sinclair connectors. It is a simple two minute job and requires no electronic skills. This keyboard does not need any soldering. Please specify on order whether you require the ZX 81 or Spectrum case.

### SPECTRUM MODEL

This is supplied with spectrum legends, and a slightly different base for fitting the spectrum inside, again all the connectors are at the rear of the case and there is plenty of room for the power supply (and other add-ons). Should you want to change, we can supply both the Spectrum legends and details of updating your case which will enable modification from the ZX 81 to spectrum. PLEASE specify on your order whether you require the ZX 81 or spectrum case.



**KEYBOARD  
(SPECTRUM/81)**

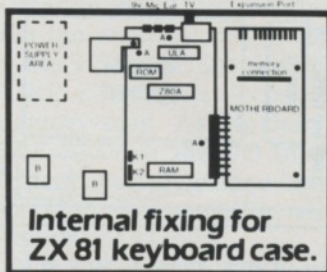

**Internal fixing for  
ZX 81 keyboard case.**

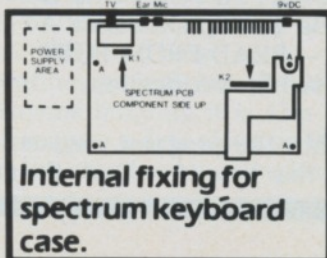

**Internal fixing for  
spectrum keyboard case.**

## SPECTRUM LIGHT PEN

The pen enables you to produce high resolution drawings on your own television set, saving a vast amount of time over using basic programming statements, such as Plot, Draw etc. You can erase, modify and save drawings and it comes complete with software program. The superb light pen is available from D.K. electronics.

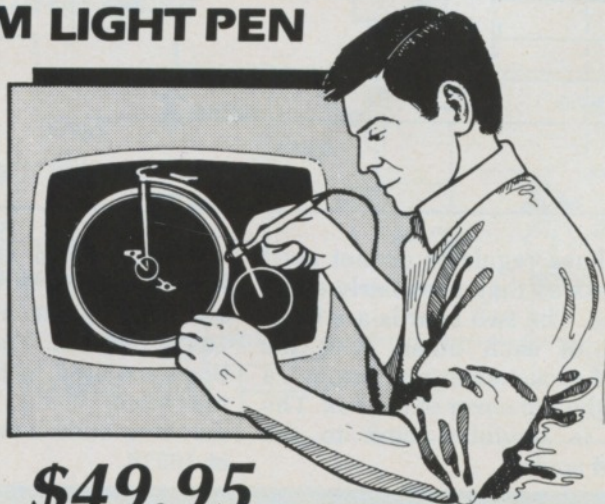

**\$49.95**

**SPECTRUM**  
16K Memory Expansion  
The 16K uses 4112 Static Ram and offers using the Static Ram speed low power and the computer. Although which comes to you where. Position in

**64K Memory Expansion**  
All the above information advantage lies in the use of other 8192-65536. The Spectrum Memory Upgrade your Spectrum it is simply slipped are supplied, and time. The fitting is the same as Sinclair's P







# Project

register that for port B, and register B that for port A. Register C contains the I/O location of the three ports and the Control Location. Register DE is used as a counter to pause for longer than 50ms — when following the machine code routine, it is useful to look at table one.

The timer has to last for 50ms, so an electrolytic capacitor is used. Because they have tolerances between plus 100 percent or minus 50 percent the pre-set is made very large to take account of it. If electrolytics are used, the timer should be set up on an oscilloscope. If an oscilloscope is not available, tantalum capacitors should be used instead. Alternatively, it is possible to feed the Q output temporarily to the port A input — any will do — and write a small program to measure the duration of the output pulse,

**Figure 5: Detail of wiring on small board**

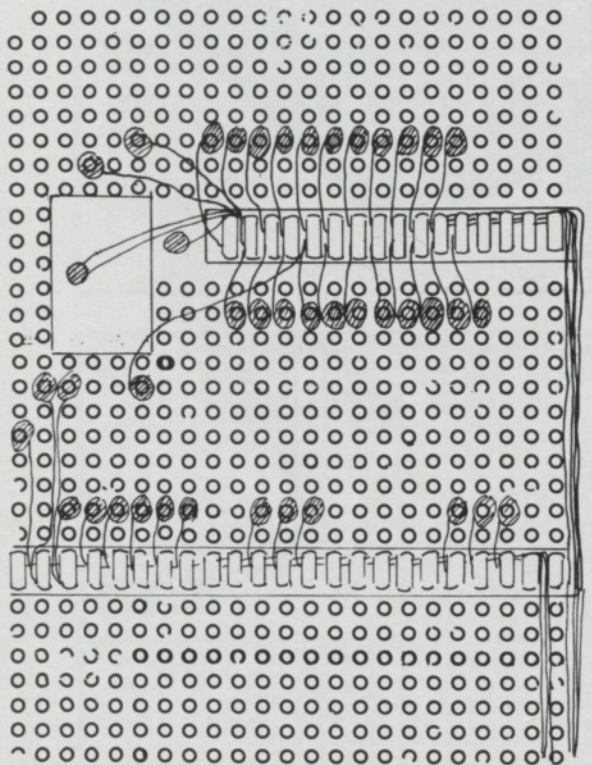
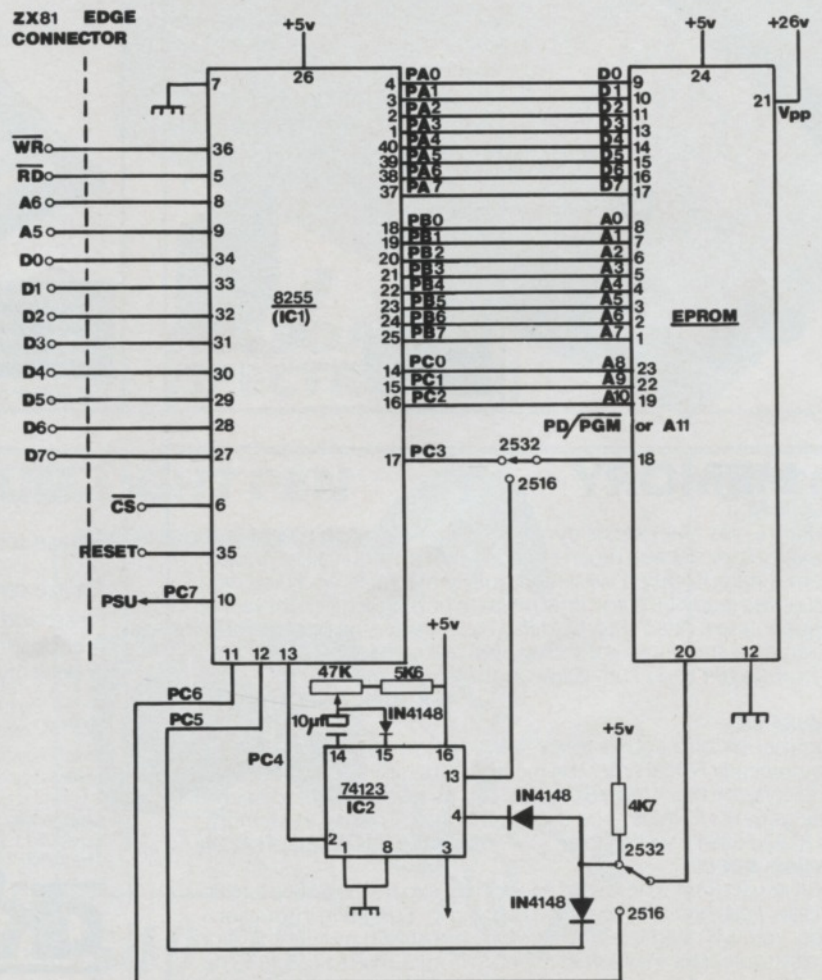

**Table 1**

2516,2K by 8-bit		Nothing	Read	Program
EPROM function				
PC0	A8	—Standard	Address	Inputs
PC1	A9	—Standard	Address	Inputs—
PC2	A10	—Standard	Address	Inputs—
PC3	Not used			
PC4	PD/PGM	Low	Low	Pulsed high
PC5	Not used	—	—	—
PC6	CS	High	Low	High
PC7	5v/26v	High	High	Low

2352,4K by 8-bit		Nothing	Read	Program
EPROM function				
PC0	A8	—Standard	Address	Inputs—
PC1	A 9	—Standard	Address	Inputs—
PC2	A10	—Standard	Address	Inputs—
PC3	A11	—Standard	Address	Inputs—
PC4	Pd/PGM	Low	Low	Pulsed high
PC5	Not used	High	Low	High
PC6	CS	—	—	—
PC7	5v/26v	High	High	Low

**Figure 6: Main circuit diagram**





# Project

## Components

1 x INS8255 (IC 1)  
 1 x 74132 (IC 2)  
 1 x 74LS32 (IC 3)  
 1 x 74LS00 (IC 4)  
 1 x 7805 (IC 5) 5v 1A regulator  
 1 x BD235 (TR 1)  
 1 x BC108 (TR 2)  
 3 x IN 4002  
 1 x BZY88 24V Zener  
 1 x BXY88 5V Zener  
 3 x IN4148  
 2 x 470  $\mu$ -F 63V electrolytic  
 1 x 2200  $\mu$ -F 16V electrolytic  
 1 x 10  $\mu$ -F 10V electrolytic  
 1 x 1  $\mu$ -F 63V tantalum  
 3 x 0.1  $\mu$ -F Polyester  
 1 x 47K ohms Preset Resistor  
 1 x 5K6 ohms  $\frac{1}{2}$ w 5% Resistor  
 1 x 4K7 ohms  $\frac{1}{2}$ w 5% Resistor  
 1 x 2K7 ohms  $\frac{1}{2}$ w 5% Resistor  
 1 x 2 pole change-over switch  
 1 x 40 pin DIL socket  
 1 x 24 pin zero force socket  
 1 x 9-0-9V 1 amp transformer  
 1 x case 16cm. x 10cm. x 6cm.  
 Veroboard—VQ board  
 Verowire  
 12in. ribbon cable—20-way  
 Nuts and bolts  
 Cassette-type chassis plug and free socket  
 Connecting wire—single plus twin mains  
 23-way double-edge connector  
 23-way double male-male PCB

```

100 PRINT "WHAT ADDRESS IN THE
EPROM"
110 INPUT Y
120 REM 3 MSB NEED TO BE A LOGI
C 1
130 LET Y=Y+57344
140 POKE 16514,Y-256*INT (Y/256
)
150 POKE 16515,INT (Y/256)
160 PRINT "ENTER NO OFBYTES TO
BE SENT"
170 INPUT A
180 DIM B(A)
190 FOR C=1 TO A
200 INPUT B(C)
210 PRINT B(C)
220 NEXT C
230 FOR C=1 TO A
240 POKE 16516,B(C)
250 LET S=USR 16518
260 IF PEEK 16516<>PEEK 16517 T
HEN GOTO 1000
270 LET Y=Y+1
280 POKE 16514,Y-256*INT (Y/256
)
290 POKE 16515,INT (Y/256)
300 NEXT C
310 PRINT "JOB FINISHED, NO ERR
ORS"
320 PRINT "DO YOU REQUIRE TO PR
OGRAM MORE DATA IN"
330 INPUT Z$
340 IF Z$="Y" THEN GOTO 100
350 STOP
1000 PRINT "ERROR HAS OCCURRED"
1010 LET Y=Y-57344
1020 PRINT "ERROR OCCURRED AT";Y
1030 PRINT "DATA READ FROM THIS
LOCATION IS ";PEEK 16517
1040 STOP
  
```

Figure 7: Component layout for large board

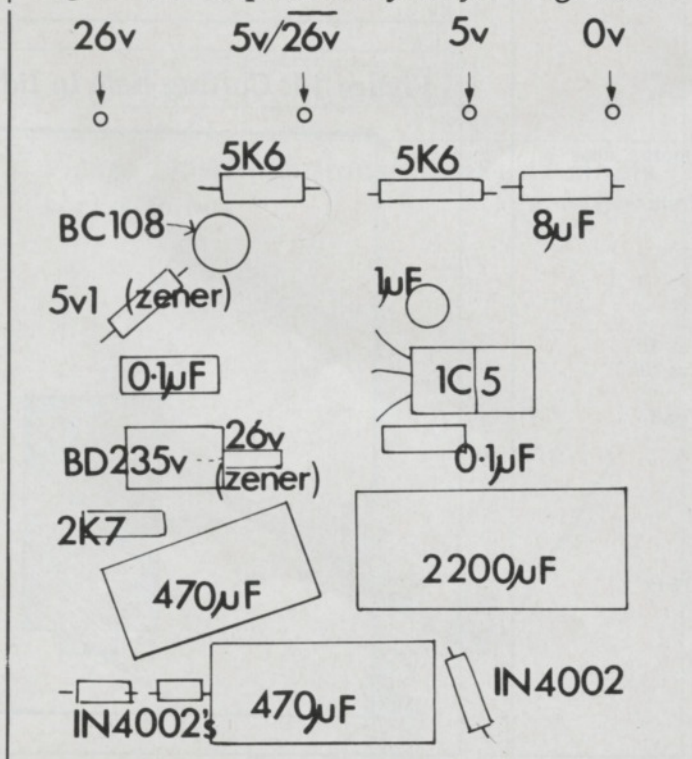
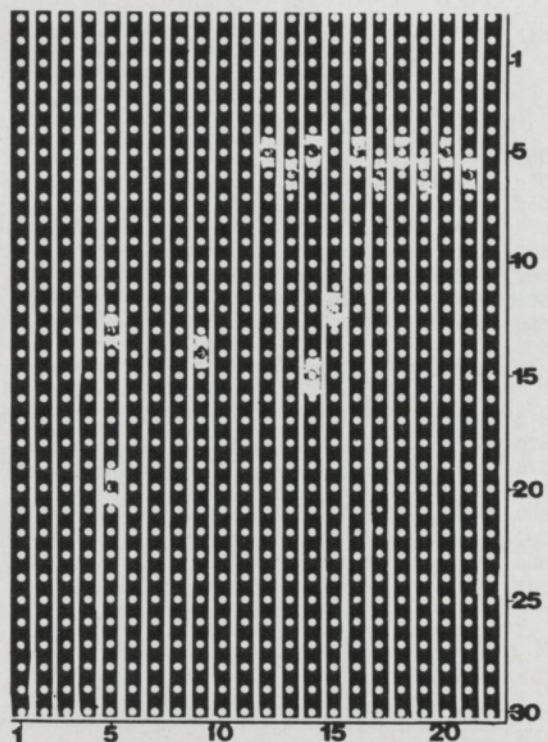

Figure 8: Cut track on back of large board





```

1 REM AAAAAAAAAAAAAAAAAAAAAAAAAA
AAAAAAAAAAAAAAAAAAAAAAAAAAAAAAAA
AAAAAAAAAAAAAAAAAAAAAAAAAAAAAAAA
AAAAAAAAAAAA
10 LET X=16518
20 INPUT Y
30 PRINT X,Y
40 POKE X,Y
50 LET X=X+1
60 GOTO 20

```

**N.B. THERE SHOULD BE AT LEAST 80 A'S IN LINE 1**

### Machine Code Table

16514				
16516				
16518	14127	LDR,N	r = c, N = 7FH	Conditions the ports as outputs
16520		LDr,N	r = A, N = 80	
16522	237121	OUT(C),r	r = A	
16524	4213064	LDHL,(nn)	nn = 16514	Sets up H, L and B.
16527	5813264	LDA,(nn)	nn = 16516	
16530	71	LDr,r	r = B;r = A	
16531	1495	LDr,N	r = C,N = 5FH	
16533	23797	OUT(C),r	r = H	Outputs
16535	1463	LDr,N	r = C,N = 3FH	H to port C
16537	237105	OUT(C),r	r = L	L to Port B
16539	1431	LDr,N	r = C,N = HFH	B to Port A
16541	23765	OUT(C),r	r = B	
06543	1495	LDr,N	r = C,N = 5PH	
16545	203188	Bit 7 Low		Begins programming Cycle.
			r = 11	
16547	203238	SETb,r	Bit 4 High	
			r = H	
16549	23797	OUT(C),r	r = H	
16551	203164	RESb,r	Bit 4 Low	Reconditions Report C does
			r = H	
16553	23797	OUT(C),r	r = H	not stop 74123 from working.
16555	1700000	LDdd,nn	dd = DE,nn = 00	
16558	29	DECm	m = E	
16559	32253	JR NZ,e	e = 1	1 10ms delay.
16561	21	DECm	m = D	
16562	32250	JR NZ,e	e = 4	
16564	14127	LDr,N	r = C,N = 7FH	Reconditions A as I/P.
16566	62144	LDr,N	r = A,N = 90	Reconditions A as I/P.
16568	237121	OUT(C),r	r = A	
16570	203180	RESb,r	Bit 6 Low	Reconditions H and
			r = H	
16572	1495	LDr,N	r = C,N = 5FH	sends to Port C.
16574	23797	OUT(C),r	r = 11	
16576	1463	LDr,N	r = C,N = 3FH	Refills Port B.
16578	237105	OUT(C),r	r = 1	
16580	1431	LDr,N	r = C,N = 1FH	Read EPROM.
16582	237120	IN(C),r	r = A	Store result at 16517
16584	5013364	LDnn,A		
16587	201	RET		

time between C4 going low and Q output returning low.

The software has been tested on a 2516 EPROM and programmed a routine successfully into it. The software for a 2432 EPROM will be given in a later issue of the magazine. E/E

**Figure 9: Cutting tracks**

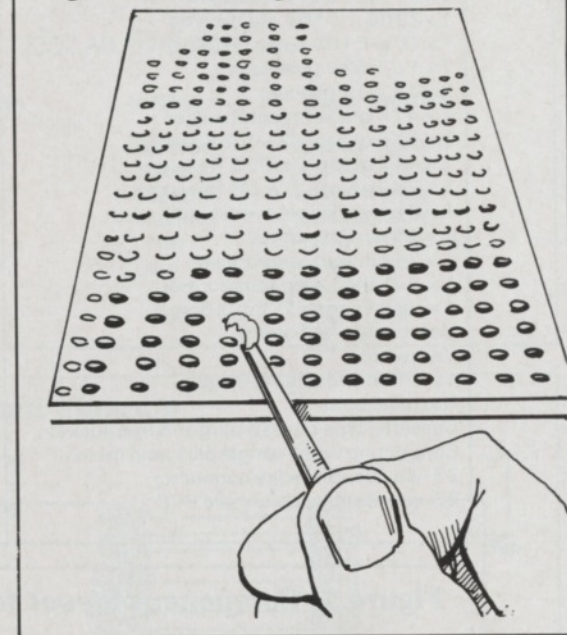

**Figure 10: Cutting hole in lid**

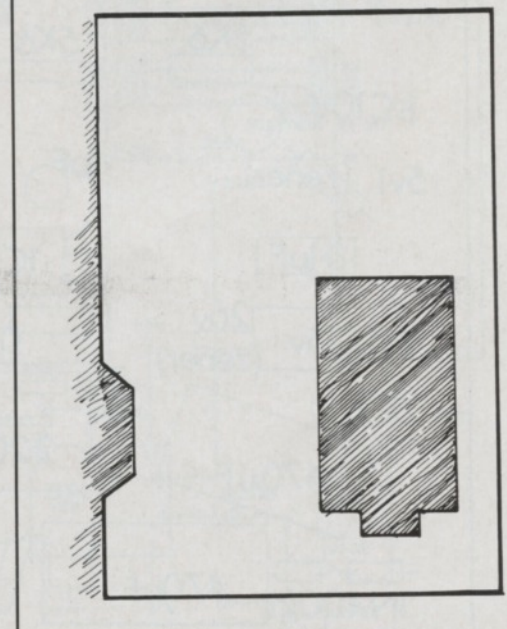



# Project

**Figure 11: Soldering large components onto large Veroboard**

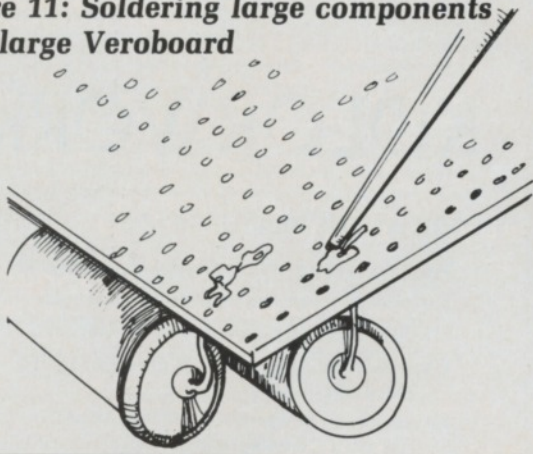

**Figure 12: Soldering wires to small board**

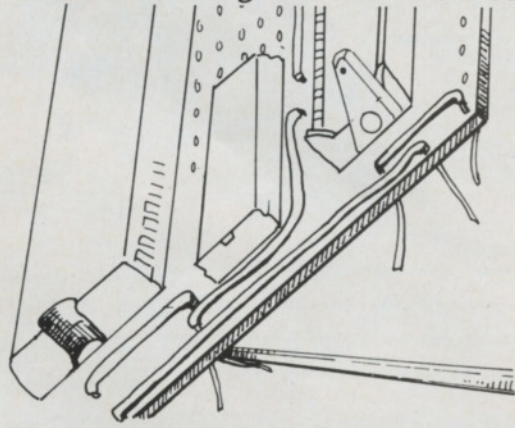

**Figure 13: Connecting fine wires along "farmers" underneath small board**

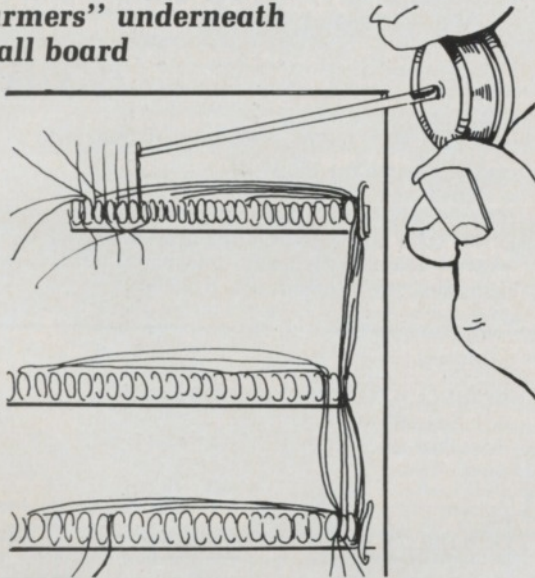

**Figure 14: Connecting small board to large board**

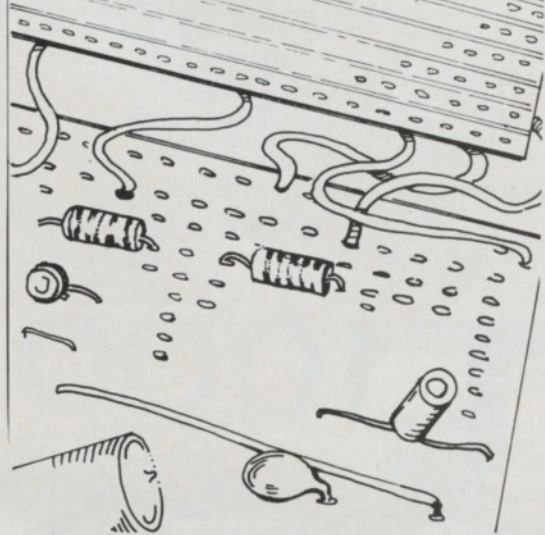

**Figure 15: Attach transformer and mains socket to box**

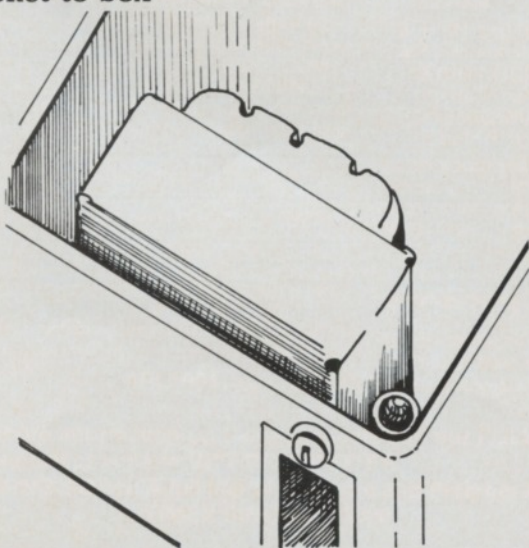

**Figure 16: Connect small board to edge connector**

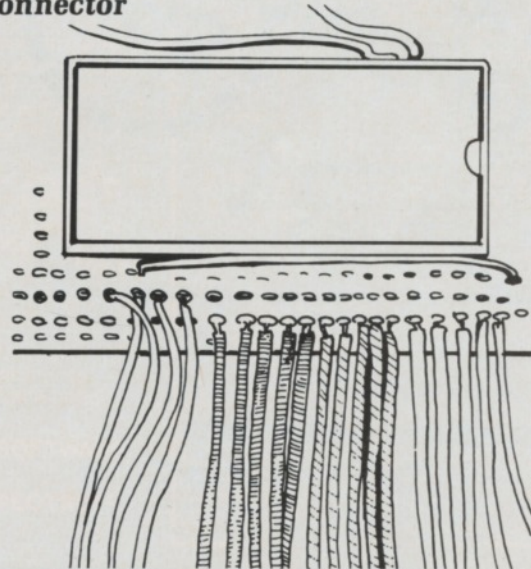



## Extend your ZX81/TS1000: Add Memory that won't Forget!

- ✓ ADD YOUR OWN SYSTEM UTILITIES
- ✓ BUILD UP A LIBRARY OF MACHINE LANGUAGE SUBROUTINES
- ✓ UP TO 8K NONVOLATILE RAM
- ✓ USE HM6116LP CMOS RAM OR 2716/2732 EPROM
- ✓ COMPATIBLE WITH 16K RAM PACKS

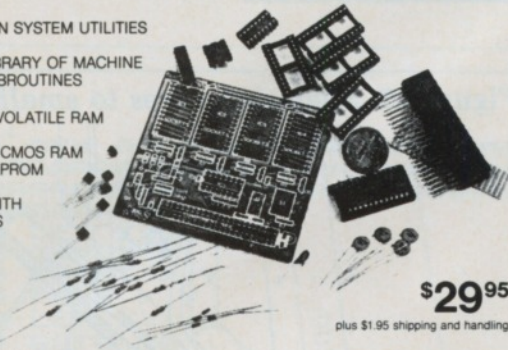

**\$29<sup>95</sup>**

plus \$1.95 shipping and handling

### ▶ READ THE REVIEWS:

What a super product!...conceived and executed very nicely...and with quality components.  
(**SYNTAX QUARTERLY Winter 82**)

8K Nonvolatile memory is a gem! It has so many possible uses...I recommend this board most heartily.  
(**OKLAHOMA S.U.G. Newsletter 1/3**)

We found the documentation to be far superior to that (of) most hardware we've received.  
(**S.U.N. Newsletter Nov/Dec 82**)

For versatility this is even better than an EPROM...ranks quite high on the list of "must-haves"  
(**SYNC Magazine Mar/Apr 83**)

### INTRODUCTION

This memory board is designed to fill the transparent 8K block of memory (from 8 to 16K) in a ZX81-16K system. This area of memory is an ideal place to store, either permanently or temporarily, machine language routines or data which are to be used by the BASIC system.

A sample display routine, a program—merging routine, and procedures for storing utilities on tape are included with the kit.

The use of HM6116LP 2K CMOS RAM memory IC's with their own reserve power supply means that routines stored in the RAM are nonvolatile — the RAM retains its memory even when the ZX81 is switched off or reset. Moreover, being RAM, the routines you store in the memory are easily modified. The lithium cell supplied with the board will maintain sufficient reserve power for almost ten years.

### ASSEMBLY

Complete step-by-step instructions in a 20 page manual make assembly of the board easy. Construction takes between two and three hours. The kit (pictured above) is complete with a silkscreened solder-masked printed circuit board, all capacitors, resistors, transistors, sockets, connectors, integrated circuits, and the lithium cell. The board is supplied with one 2K CMOS 6116LP-3 RAM — it will accommodate three more for a total of 8K.

Complete kit with 2K	\$29.95
Additional three 6116LP-3	\$16.00
Bare pc board & manual	\$13.05
Assembled & tested with 2K	\$44.95
Assembled & tested with 8K	\$59.95
Shipping & handling per order	\$ 1.95

Send check or money order to the address below.



HUNTER, 1630 FOREST HILLS DRIVE, OKEMOS, MI 48864

For more information, circle 20 on reader service card.

# T1000

High Resolution Graphics \$60

114 PLOT modes including:

Points and various line types  
Textured triangle fill  
Absolute and relative co-ordinates  
Line drawing to points off screen

Mixed text and graphics including PRINT at graphics cursor.

User defined graphics for space invaders etc

Screen COPY to printer

MAIL ORDER SHOP

**Notling Dale Technology Centre**  
189 Freston Road, London W10 6TH  
Telephone: 01 969-8942

For more information, circle 22 on reader service card.

## CHANGE YOUR TIMEX/SINCLAIR 1000 DISPLAY TO FULL COLOUR GRAPHICS

with

# KOLORWORKS

### LOOK AT THE FEATURES !!!

- \* Plugs into ZX81/1000 (edge connector)
- \* All text will run on the color tv
- \* Module contains it's own memory
- \* User defined characters & graphics up to 256x192 pixels
- \* Latest technology with TMS9918 VDP (32 sprite levels)
- \* Module contains extension of basic commands including: PAPER/INK/BORDER/BIN/SPRITE/OUT/INP/ etc.

for **\$149.95**

Use your KOLORWORKS immediately with a game cassette for **\$9.95**

This delightful game is designed for hours of fun using some of the color graphic capabilities of KOLORWORKS. The cassette also contains a short program to familiarize you with some of the commands and graphics.

### MAIL TO:

BRAINCHILD COMPUTER WORKS, INC.  
P.O. Box 506  
Pewaukee, WI 53072

	Price +	Qty.	Amount
KOLORWORKS	\$149.95		
CASSETTE	9.95		
Shipping and Handling	4.95		\$4.95
Wi. Res. add Sales Tax			
My <input type="checkbox"/> check <input type="checkbox"/> money order enclosed			<b>TOTAL</b>

Name \_\_\_\_\_

Street \_\_\_\_\_

City \_\_\_\_\_

State \_\_\_\_\_

Zip \_\_\_\_\_

Please allow six to eight weeks for processing. Thank you.

For further information - Send \$2.00 (credited to order)

WATCH FOR:

"GAAMWORKS" -

Joystick Ports / Sound / Cartridge Slot

For more information, circle 21 on reader service card.

TIMEX SINCLAIR USER June 1983







# User Groups

## Vast support network growing

**A** VAST support network exists for the T/S1000,ZX81: wherever goes the most popular computer in history, user groups are not far behind. Below is a list of many such groups in the United States; as new ones are springing up all the time, we make no claims that it is inclusive. Whenever two or more



### Subscription Offer

**Timex Sinclair User** extends a special offer to User Groups! Your group can earn \$125 or more to help pay for your newsletters, speakers' fees, renting meeting space and so on. To earn your "Bonus Bucks," sign 25 members or more as subscribers to *Timex Sinclair User* at \$29.95 each; send us a cheque for only \$24.95 per order; keep the \$5 cash bonus for each order (minimum 25), and earn at least \$125 for your group.

Each subscriber will receive, at no extra charge, a cassette of an exciting new arcade game, "Packrabit" (retail value \$15). Special offer valid for limited time only.

T/S1000,ZX81 enthusiasts meet, there you see the beginnings of a group; and as there are now more than 600,000 T/S1000,ZX81 computers sold in the United States, such meetings are becoming increasingly common. So if we have omitted your group, we apologize — and do let us know so we can include it in an update. ☺☺

#### CALIFORNIA

Bay Area ZX User Group  
2660 Las Aroma  
Oakland CA 94611  
Pacifica TS/ZX Users' Group  
263 Gateway #107  
Pacifica CA 94044  
Contact: George Mockridge  
415-359-3198

Perkin-Elmer Users' Group  
8333 Pumalo  
Alta Loma CA 91701  
Contact: Rein Smith

San Francisco Bay Area T/S  
User Group  
947 Clara Drive  
Palo Alto CA 94303  
Contact: Dr. Paul Perreault  
408-734-5300

West L.A. Sinclair/Timex User  
Club  
P.O. Box 34545  
Los Angeles CA 90034  
Contact: Dr. George Kuby  
213-550-5035

**WASHINGTON, D.C.**  
Washington Area Users  
P.O. 6239  
Washington DC 20015

**FLORIDA**  
Florida Suncoast Users'  
Group  
P.O. Box 5021  
Spring Hill FL 33526  
Contact: John Dowlan

Sam-Bam Users' Group  
P.O. Box 596  
Safety Harbor FL 33572  
Contact: Mel Rountt  
Sinclair/Timex SE Region  
Newsletter

869 Levitt Parkway  
Rockledge FL 32955  
Contact: Ralph M. Coletti  
305-853-6901  
Space Coast Microcomputer  
Club  
70 Darwin Ave.  
Merritt Island FL 32952  
Contact: Bruce Hosken

**GEORGIA**  
Atlanta Users' Group



P.O. Box 2842  
Atlanta GA 30301  
Contact: Phil Hoffstadter  
404-529-4326

**ILLINOIS**  
Chicago Area Users' Group  
323 S. Franklin #804  
Chicago IL 60606  
Contact: Larry Weigel

Circle Chess Group  
P.O. Box 63  
Des Plaines, IL 60017  
Contact: A.F. Standis  
Sinclair Users' Network  
2170 Oak Brook Circle  
Palatine IL 60067

Contact: Diana Wright  
312-934-9375

**INDIANA**  
Sinclair Midwest Users'  
Group  
P.O. Box 13042  
Fort Wayne IN 46866  
Contact: Robert C. Carroll

**LOUISIANA**  
Gulf Coast Sinclair Users'  
Group  
144 Terry Dr.  
Slidell LA 70458

**MARYLAND**  
Amateur Radio Group  
5448 Tilden Road  
Bladensburg MD  
Contact: Jim Wallace  
Prince George's Sinclair  
Users' Group  
5448 Tilden Road  
Bladensburg MD  
Contact: Jules Gesang  
301-243-2550  
Seabrook/Lanham Sinclair

Users' Group  
9528 Elvin Lane  
Lanham MD 20706  
Contact: Cora C. Dickinson

**MASSACHUSETTS**  
Boston Computer Society  
3 Center Plaza  
Boston MA 02136  
Contact: Sue Mahoney

Mitre Bedford Sinclair/Timex  
Computer Club  
Box 208, E170 Mail Stop  
Bedford MA 01730  
Contact: Ed Lindsay

**MICHIGAN**  
Michigan Area Users' Group  
433-D E. Edgewood Blvd.  
Lansing ML 48910

**NEBRASKA**  
S.U.N. (Sinclair Users'  
Network)  
4903 Walker  
Lincoln NE 68504  
Contact: Patrick Murphy  
402-464-8086

**NEW YORK**  
DataAmerica Computer  
312 E. 84 St. #1A  
New York NY 10028  
Upperstate New York ZX81  
Users  
13 Dennis Ave.  
Plattsburg NY 12901  
Contact: Vern Olsen  
ZX Users' Group of America  
626 Water St.  
New York NY 10002  
ZX Users' Group of New York  
Box 590, Mall St.  
New York NY 10005  
Contact: Caroline Vivanco

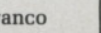
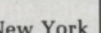
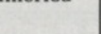
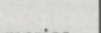
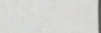
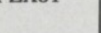
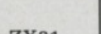
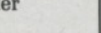
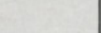
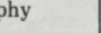
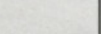
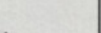
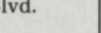
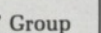
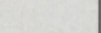
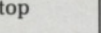
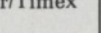
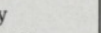
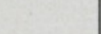
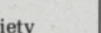
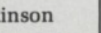
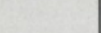
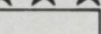
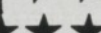
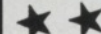

#### NORTH CAROLINA

Triangle Sinclair Users'  
Group  
P.O. Box 12546  
Research Triangle Park NC  
27709  
Contact: John Drummond  
919-543-8006

**PENNSYLVANIA**  
Central PA TS/ZX Users'  
Group  
RD 1, P.O. Box 539  
Centre Hall PA 16828  
Contact: Bill Russell  
814-364-1325

Pittsburgh Area Computer  
Club,  
Special Interest Group —  
Sinclair  
1605 Middlecrest Drive  
Glenshaw PA 15116  
Contact: Dick Welsh  
412-487-0789

**TENNESSEE**  
Chatanooga Area Sinclair  
Users  
P.O. Box 1321  
Collegedale TN 37315  
Contact: Dan Williams

**TEXAS**  
Timex Educator's User's  
Group  
School of Education,  
Texas Wesleyan College  
Fort Worth TX 76105  
Contact: Mark Wasicsko  
817-531-4440

**VIRGINIA**  
Central Virginia Users' Group  
Rt. 1, Box 192,  
Troy VA 22974

Colonial Pennwild TS User  
Group  
146 Hawthorne Drive  
Newport News VA 23602  
Contact: Jim Langston  
804-877-3920

**WEST VIRGINIA**  
Sinclair Super Group  
949 Brier St.  
St. Albans WV 25177  
Contact: William Meclaw



In the U.K.,  
home of the world's  
best-selling  
computer, you'd  
buy through  
Prism.

Now, in the U.S.A.,  
you can buy the  
best-proven  
programs from  
Prism...



Available  
now!

# Spread-sheet planner challenging games, educational



Over a million people world-wide have bought a Timex Sinclair personal computer, and every month the figure grows.

And it's true of any serious computer that 'the software makes the system'.

So, what better software to buy than Prism software? As Exclusive Trade Distributors for the Sinclair range of computers, peripherals and software in the U.K., Prism in-depth knowledge and experience is unrivalled.

With a significant reputation to maintain, you can be sure Prism software has been thoroughly 'field-proven'.

Spread-sheet planner, word processing, challenging games, educational programs . . . now they're all available to you in North America.

They give you even more scope with your TS1000, and allow you to use your computer immediately\*.

This easy-to-use software is even easier to order! Complete and mail the coupon opposite for the programs of your choice — today.

*\*16K programs require 16K RAM memory pack.*

## ADVENTURE

- A1. Samurai Warrior** — A game where, as a Samurai warrior, you battle with other Samurai and with bandits to protect villages. Can you become Shogun? (16K)
- A2. Tyrant of Athens** — Disasters, famines, attacks from land and sea. Can you resist them all and remain Lord of Athens? (16K)
- A3. Roman Empire** — Send legions to conquer Mediterranean countries — and if you succeed, crown yourself Caesar! (16K)
- A4. Peloponnesian** — A re-enactment of the famous battles between Athens and Sparta. Try to win allies and influence people before the final battle! (16K)
- A5. Warlord** — You'll need swift judgement to protect your village from marauding bandits and Samurai, your fleet from pirates, and your people from slavery. (16K)
- A6. Escape From Manhattan** — MAY DAY . . . MAY DAY . . . The President's plane has crashed, on an island of convicts! Get there! Get him! Then get out again! (16K)
- A7. Demon Adventure** — Standard-text adventure game with real-time battles and which relies on complexity rather than difficulty of play. (16K)
- A8. The Thing** — A graphic adventure game set in the Antarctic. Escape to the helicopter and save your life — if you can. (16K)

## ARCADE ACTION

- R1. J.D. Arcades** — Three popular m/code games with some novel twists. (16K)
- R2. Outrider** — Save your mother ship. She's being assailed by aliens! (16K)
- R3. Xaraks** — Get round the maze without

# All designed to let you most from your TS1000



# ning, word processing, ucational programs...

the guard catching you. And if you want to make things difficult for yourself, there are nine levels of play, all m/code. (16K)

**R4. Avenger** — A classic. Can you win the planet? Destroy oncoming missiles, bombs, and the city below to stake your claim. (16K)

**R5. Protector** — Defend your ship against oncoming missiles. Can you create the highest-ever score? (16K)

**R6. Bomber** — You must land, but not before all alien life forms are neutralized . . . but they want to neutralize you! (16K)

**R7. Alien Rain** — There's an Extra Terrestrial on one side of the screen, and you're on the other. It's raining — bombs! Please try and rescue the Extra-Terrestrial. (16K)

**Program listing  
continued overleaf!**



**get the  
0...Now!**

## Now order your TS1000 programs direct from Prism— the TS1000 experts . . .

### Adventure

- A1. Samurai Warrior .. \$9.95
- A2. Tyrant of Athens .. \$9.95
- A3. Roman Empire .... \$9.95
- A4. Peloponnesian .... \$9.95
- A5. Warlord ..... \$9.95
- A6. Escape From  
Manhattan..... \$14.95
- A7. Demon Adventure . \$9.95
- A8. The Thing ..... \$9.95

### Arcade Action

- R1. F.D. Arcades ..... \$9.95
- R2. Outrider ..... \$9.95
- R3. Xaraks ..... \$9.95
- R4. Avenger ..... \$9.95
- R5. Protector ..... \$9.95
- R6. Bomber ..... \$9.95
- R7. Alien Rain..... \$9.95

### Business

- B1. Word Processor .. \$19.95
- B3. Trawler..... \$9.95

### Challenge

- C1. Video Map ..... \$9.95
- C2. Golf ..... \$9.95
- C3. Pilot ..... \$9.95

### Computer

- P1. Hi-Res Package .. \$19.95
- P2. Video Graph ..... \$14.95
- P3. Video Sketch ..... \$14.95

### Games

- G1. Party Tricks ..... \$9.95
- G2. Music Program.... \$9.95

Total	<input type="text"/>
Postage & Handling \$1.50 per item (\$8.00 maximum)	<input type="text"/>
N.Y. Residents add 7% Sales Tax	<input type="text"/>
<b>TOTAL ORDER VALUE</b>	<input type="text"/>

Check  Mastercard  Visa  Money Order

Card No. \_\_\_\_\_ Exp. date \_\_\_\_\_

Cardholder's signature \_\_\_\_\_

Name \_\_\_\_\_

Address \_\_\_\_\_

City \_\_\_\_\_ State \_\_\_\_\_ Zip \_\_\_\_\_

Please allow 4-6 weeks for delivery.

**Please send coupon with payment to:**

**PRISM MICROPRODUCTS**

**49 La Salle Avenue**

**Buffalo, N.Y.. 14214**

Prism Microproducts are published and distributed in North America by International Publishing & Software Inc.





Order your TS 1000 programs  
today - direct from Prism, the  
TS1000 experts.



# TS1000 programs

*Complete the details on the other side  
of this coupon and send with payment to:*

**PRISM MICROPRODUCTS INC.**  
49 La Salle Avenue  
Buffalo, N.Y. 14214

## BUSINESS

**B1. Word Processor** — Use your TS1000 to familiarise yourself with word processing. If you have a printer, prepare a letter to your friends. (16K)

**B2. The Spread-sheet** — Prepare forecasts, budgets, projections and models. This spread-sheet planner for the TS1000 brings professional computer techniques within everyone's reach. (16K)

**B3. Trawler** — A business-management game set in the North Sea. Can you match the catch of a top trawler captain? (16K)

## CHALLENGE

**C1. Video Map** — Navigate your plane cross-country. Sounds easy? If you go off course . . . (16K)

**C2. Golf** — Play your game of golf in the comfort of your own home! But don't be deceived — you still have to deal with sand, rough, trees, etc. (16K)

**C3. Pilot** — That's you. Can you land your plane safely in the dark? (16K)

## COMPUTING

**P1. Hi-Res Package** — Greatly enhances the graphics facilities of your TS1000, increasing the resolution to 256 x 192. (16K)

**P2. Video Graph** — Despite the name this one doesn't plot graphs! Instead, this fascinating program enables you to create pictures which can be stored, and then merged — like an Identikit. (16K)

**P3. Video Sketch** — Use the full graphics facilities of the TS1000 — draw, type, use the large alphabet and reverse images. (16K)

## GAMES

**G1. Party Tricks** — A range of programs with listings supplied, to give the novice an insight into the TS1000 BASIC. (1K)

**G2. Music Program** — Compose your music on the TS1000. With the aid of an amplifier it can play for you (16K)

**PRISM**

MICROPRODUCTS

**PRISM MICROPRODUCTS INC.**

49 La Salle Avenue  
Buffalo, N.Y. 14214



## GLOSSARY

**Basic** — Beginners' All-purpose Symbolic Instruction Code. A programming language resembling English which is used by beginners because most popular microcomputers have it as standard.

**Bug** — an error in a program.

**EPROM** — Erasable Programmable Read-Only Memory. Semi-permanent storage. Information is not erased if the power is turned off in the computer. Programs can be erased by subjecting the memory chips to ultra-violet light. The memory can then be reprogrammed using an electrical device called an EPROM blower.

**Interface** — RS232 and Centronics. A device which enables other computers or add-ons, such as printers, to be connected to the computer. It converts non-standard signals from add-ons to the standard signals of the computer in use.

**Kilobyte (K)** — A measurement of memory size. Most machines use 16K as a minimum but 48K is generally agreed to be necessary for serious work.

**Machine code** — An electronic pulse code used by the computer to perform functions and communicate with memory and other devices.

**Mnemonics** — Abbreviated instructions — for example LD for Load — used in machine language programming.

**Motherboard** — An external printed circuit board which is used like a multi-way plug planner. It enables other printed circuit boards, such as graphics boards and color boards, to be slotted in.

**Port** — A link to the outside world which can be used by programs and the computer.

**PCB** — Printed Circuit Board. A board which has on it the electronic circuits of the computer.

**RAM** — Random Access Memory. Information and programs can be stored in this type of memory as electronic pulses which conform to a set of numbers — machine language — in which programs are represented in the computer. When the power is turned off the information will be lost.

**ROM** — Read Only Memory. Information stored in this type of memory is not lost when the power is switched off.

**Software** — Programs which control the operation of the computer.

**Syntax error** — a bug caused by incorrect use of a programming language.

# The basic route to a habit-forming hobby

## Our easy-to-follow guide for new owners

**B**UYING a Timex Sinclair machine can be the start of a lifetime obsession with home computing. It is easy, however, to become discouraged if everything does not go according to plan from the beginning.

For those with only a little knowledge of computers and their capabilities, the best way to approach the machine is to abandon any ideas for special uses. It is better to become familiar with the many facilities and then decide how you wish to use them.

Begin by unpacking your machine, overcoming your surprise at its size and weight and, following the manual, set up the system. If you cannot get the K on the screen, check that everything is plugged in-

to its correct socket and reset the machine by pulling out the power plug for one second and plugging it in again. If still nothing appears, check the power supply unit by shaking it. If it rattles, return it. If it is okay, check your system with that of a friend.

Once the K appears you are ready to begin learning about your machine. It can prevent family arguments if you can afford a separate television set for your system. It also makes life easier if you set up your equipment permanently somewhere. A few power sockets and a four-way block connector on a short length of extension cable will help make it tidy.

The manual is written in great detail and is reasonably easy to follow. Some of the chapters may not seem immediately relevant but it is worthwhile reading them as you might miss something important.

At this stage, patience is needed in learning the ways in which the computer will accept information. It is tempting to try to enter programs before you are ready but that is likely to lead to errors. For example, words like AND, THEN and AT should not be typed in letter by letter.

By the time you have reached chapter 11 in the T/S1000,ZX81 manual, you should have accumulated sufficient knowledge to be able to type in other people's programs, such as those in *Timex Sinclair User*.

It is important when using the T/S1000,ZX81 that it is not jolted. Some of the connections can easily work loose and everything which has been entered will be lost.

As a way of relaxing you can buy





some of the growing range of commercially-produced software. This can be loaded directly from cassette but make sure that your machine is big enough to take the tapes you buy.

The tapes vary in quality, and it is advisable to read the reviews in *Timex Sinclair User* and use your judgment to find the best.

An alternative method to learn about the T/S1000,ZX81 is to plunge in at the deep end and see what the machine will do. Refer to the manual when you have difficulties. You can ignore the functions and calculations initially and experiment with PRINT statements to obtain the feel of the machine.

You may already have heard about the problem involved in SAVEing and LOADING your own cassettes.

Usually they occur when LOADING tapes recorded by other people. One simple method to overcome this is to wind the tape to the middle of the program and type LOAD"" followed by ENTER; then increase the volume of the recorder slowly with the tape running until the television screen shows four or five thick black bands. If you then rewind the tape, the program should LOAD normally.

Finally, a health warning. Apart from any practical uses, computing with your Timex Sinclair machine can be a very entertaining hobby and is almost certainly habit-forming. You may easily find yourself crouched over your machine, red-eyed, in the early hours of the morning thinking that in another five minutes you will solve the problem. Try to break that habit by getting into the fresh air and meeting other Sinclair users.

By obtaining a Timex Sinclair computer you find that you have joined a not very exclusive club with many thousands of members, many of whom would be only too happy to advise you if you have difficulties.

Make sure of your regular copies of *Timex Sinclair User* and you can be guaranteed many happy hours.



## Get more out of your TIMEX/SINCLAIR with software from RUN-IT!

Many unique programs including:  
GRAPH-IT  
COMPUTER AWARENESS  
REAL ESTATE ADVISOR  
MORTGAGE/LOAN ANALYZER  
MARKET GURU  
MATH & STAT PROGRAMS  
New cassette programs every other month!  
All with easy-to-use manuals!  
SEND FOR FREE CATALOG!

**Run-it** Software  
Dept. 106, 732 S. Sherman  
Chicago, IL 60605

For more information, circle 25 on Reader Service Card.

## COMPUTER CASSETTES



**BASF  
-DPS**

THE WORLD'S FINEST  
Data media for all microcomputers.  
Used nationwide by software manufacturers, hobbyists, schools and businesses. Premium 5-screw shell with leader fits all standard recorders.

SATISFACTION GUARANTEED OR MONEY BACK.

ITEM	1 DOZ.	2 DOZ.
C-05	7.50	13.50
C-10	8.00	14.40
C-20	10.00	18.00
Hard Box	2.50	4.00

Send for free brochure. Ask for quantity discounts. Call. Residents add sales tax. SHIPPING: HANDLING (UPS) 1 doz. \$2. 2 doz. \$3.50. 3 doz. \$4.50. ea. additional doz. \$5.00. For parcel post instead of UPS, add \$1. Outside Continental USA, add \$2.

FOR IMMEDIATE SHIPMENT  
USE YOUR VISA OR MASTERCARD CALL 213/710-1430.

**YORK 10™ Computerware**  
24573 Kittridge St., TS Canoga Park, CA 91307

For more information, circle 27 on Reader Service Card.

### ATTENTION TIMEX/Sinclair 1000 and Sinclair ZX-81 owners

If you haven't bought a 16K RAM pack yet because they're too expensive or because you simply don't feel like waiting around for a couple of months, then take a look at ours. Our 16K RAM pack is only \$39.95 for a kit and is available for immediate delivery.

**NOT ONLY THAT,** but our RAM packs are significantly more reliable than others you've seen advertised at a higher price.

STATE-OF-THE-ART DESIGN

**16K RAM PACK \$39.95**  
Assembled and tested—\$44.95, case \$4.95.  
Shipping and handling \$2.95.  
Florida residents please add 5% sales tax.

**Lasercan Electronics Corporation**  
2305 Broadway, Riviera Beach, FL 33404  
(305) 842-4255 (let ring)

Please call or send SASE for information.  
We will send you our information sheet along with a FREE tic-tac-toe listing.

For more information, circle 26 on Reader Service Card.

# LEARN TO PROGRAM

Text and File Organizers with  
**ZX DATA FINDER**

A high capacity information storage and retrieval tool for 16 K Timex and Sinclair Computers.

Advanced file input and editing routines are thoroughly analyzed.

Comprehensive search and display methods are fully explained.

## AN ADVANCED COURSE IN DATA HANDLING

Free specifications are available, or send \$9.95 for program listing and text to:

**THOMAS B. WOODS**  
P.O. Box 64, Jefferson, N.H. 03583

For more information, circle 28 on Reader Service Card.

## TIMEX-SINCLAIR ZX81 1000



### 1983 Directory

- Where to find: Disk Drives, RAM Extensions, Printers, Modems, Keyboards, Game & Serious Software, Books, Periodicals, Programming Aids, and other Exciting Accessories!
- Articles on: Special applications like Control Circuitry, Enhanced Graphics, Voice Generation, Music Synthesis, Video Inversion, Light Pens, Joysticks, etc.
- Complete Descriptions: We'll tell you what it is, what it does, how much it costs, and where to buy it.
- Jam-packed w/photographs: We knew you'd want to see what these products look like. So, we got pictures and put them in!

**Only \$5.00 ... Postpaid!**

To Order: Send check, money order, or VISA/MC number and expiration date. MN residents add 6% sales tax.

Dealer Inquiries Welcome.

**E. Arthur Brown Company**  
Dept. 1702 Oak Knoll Drive  
Alexandria, MN 56308 Ph: 612/762-8847

## TIMEX/SINCLAIR COMPUTER USERS We Have The Books You Need



- ART OF PROGRAMMING THE 1K ZX81.**  
How to use the features of the ZX81 in programs that fit into the 1K machine. 96pp. \$5.75 postpaid.
- ART OF PROGRAMMING THE 16K ZX81.**  
How to use your 16K RAM pack and ZX printer to the full. 144 pp. \$6.95 postpaid.
- ART OF PROGRAMMING THE ZX SPECTRUM.**  
Everything you need to know to put the ZX Spectrum to work for you. 144 pp. \$8 postpaid.

ELECTRONIC TECHNOLOGY TODAY, INC.  
P.O. BOX 83  
MASSAPEQUA PARK, NY 11762

Name: \_\_\_\_\_  
Address: \_\_\_\_\_  
City: \_\_\_\_\_ State: \_\_\_\_\_ Zip: \_\_\_\_\_

Number of books ordered TSU 2

For more information, circle 30 on Reader Service Card.



## Vast database soon available to Sinclair users

Nigel Clark reports from Britain on the promises of more expansion

**W**ITH THE next new computer from Sinclair Research not expected until next year, attention in the U.K. is being focussed on expanding existing systems.

The two major expansions for which Sinclair owners are eagerly waiting are the Microdrives and Micronet 800. Both have been announced but neither is yet available.

The Microdrives are expected soon but Sinclair is refusing to give any details about when it will go on sale or what it contains.

It is believed to be a tape loop which will allow an extra 100K of memory to be added to the Spectrum, the U.K. version of the T/S2000. The necessary interface will allow up to eight drives to be attached. Each drive should cost £40 (\$58) and the interface will be about £30 (\$43).

While these expansion possibilities seem large, the opportunities offered by Micronet 800 are enormous.

Micronet 800 is a 30,000 page database of information to which Sinclair computer owners will be able to attain access via the telephone network for the cost of a £50 (\$72) adaptor plus a membership fee and usage charges.

Micronet 800 is a new service on British Telecom's existing Prestel network. Prestel allows owners of customized TV to attain access to information on everything from the weather to theatre booking facilities.

Now with the addition of Micronet 800 database the whole Prestel network is opened up to microcomputer owners.

Subscribers will be able to

download programs of all types, have the latest news and reviews on what is happening in the world of personal computing, have the use of an electronic mail system, and there will be a section which clubs can use to contact members. They will also have access to the full Prestel database.

Adaptors are being produced for the full range of Micros in the

British market, but as yet they are not available for the Spectrum or the ZX81. The system has already been launched with adaptors for the BBC Model B, Apple II and PET, and interest has been very good. However, the backers will not know if the system will be a success until they bring in users of the market leader. It is intended to have an adaptor for the Spectrum by this month, with the ZX81 being catered to later in the year.

Some delay has been caused by a breakdown in relations between Sinclair Research and a firm called Martochoice, which was a joint winner of a competition for a Prestel adaptor for the ZX81 last year. They were cooperating to produce an adaptor for the Spectrum, but this fell through this year because of a disagreement within Martochoice. For the moment, Sinclair has dropped its own plans for providing telesoftware, but Micronet is going ahead with an adaptor from another source.

It is seen in many circles as the possible savior of the pioneering Prestel Viewdata service. Interest in the service has been slow to build up with businesses being the main customers. Users needed a relatively expensive specially-adapted television set and the cost of using the systems was also thought to be high for the home. The rapid growth in home computing has provided a means for changing all that.

An adaptor at a reasonable price and lower user costs has already generated a lot of interest, which is expected to be quickly translated into a growing number taking advantage of the latest telecommunications technology. ☺





# Subscribe here

for Britain's First Electronics & Computer Applications Magazine, the publication with a unique blend of theory, projects, software and product reviews, plus science and general features on a wide variety of computing and electronics topics.

To keep well informed of changes in computer technology send the coupon today.

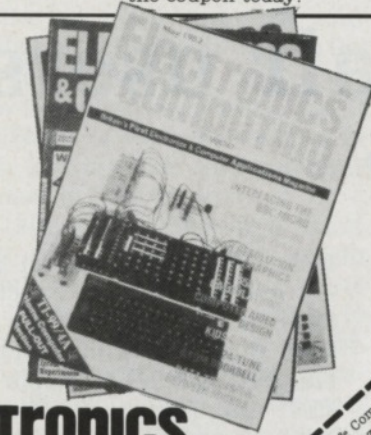

## Electronics & Computing

Please put coupon in a sealed envelope to  
Electronics & Computing Monthly  
Subscription Dept  
Competition House  
Farndon Rd  
Market Harborough  
Leicestershire  
England

I would like to subscribe to Electronics & Computing Monthly and enclose a cheque for £25 Air Mail, \$13.95 Surface Mail.

Name \_\_\_\_\_  
Address \_\_\_\_\_  
Signature \_\_\_\_\_

ECM/10

For more information, circle 33 on reader service card.

## Synchro-Sette

The Subscription Magazine for the  
**SINCLAIR ZX-81 / TS-1000**  
MICRO COMPUTERS

Games, Educational,  
Business, Graphics, Tutorial, Etc.

12 Month Issues —  
6 Bi-Month Cassettes  
At Least 6 Programs Each

### \$39.50

Illinois residents add \$2.07 Tax  
Outside U.S.A add \$10.00

24 HOUR HOT LINE:  
**(800) 543-1300**

Ask For Operator 383.  
**THE S & S COMPANY**  
388 W. Lake Street  
Addison, Illinois 60101



**(312) 628-8955**

For more information, circle 31 on reader service card.

# RAMPAK 16

16K RAM EXPANSION  
FOR TIMEX/SINCLAIR

1000/ZX81

## GROW WITH US!

EXPANSION PRODUCTS FOR YOUR MICROCOMPUTER



Expand your Timex/Sinclair with RAMPAK 16. Just plug in RAMPAK 16 and get 16K of additional RAM memory. No additional power required. Packaged in an attractive black case. Every RAMPAK 16 has a Lifetime Warranty when the warranty card is returned to MSD. Ask for us by name, MSD.

**Dealer Inquiries:**

**1-800-527-5285**

**Mail Orders:**

**Southwest Micro**  
**214-484-7836**

Times/Sinclair 1000 ZX81 Trademark of Timex/Sinclair. RAMPAK 16 Copyright of Micro Systems Development, Inc.

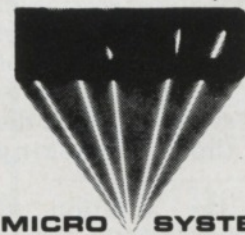

**MICRO SYSTEMS DEVELOPMENT, INC.**

(214) 241-3743

11105 Shady Trail • Suite 104 • Dallas, Texas 75229

For more information, circle 32 on reader service card.

TIMEX SINCLAIR USER June 1983



Use your computer in the case...  
 Foam rubber gives complete protection...  
 Purpose-built for Timex/Sinclair systems...

# TS 1000 and 2000 Custom Cases. Just \$79.95 (inc. postage/handling) each.



## Turn your Timex/Sinclair system into a portable computing centre!

Your TS hardware – 1000 or 2000 – is designed to work together as a system. And now there's a simple way to make the most of the fact.

**The portable computing centre in a briefcase.**

A TS Custom Case holds all your hardware in the most ergonomically

sensible positions for easy operation. Each piece of equipment is gripped securely by shock-absorbing foam. Each connecting lead fits under the foam, so there's no chance of tangles. And as each piece is held firmly, connections are excellent.

You can forget wasted time setting up or unhooking the system, too. When you've finished, simply tuck in the mains and TV leads and replace the hinged, lift-off lid. And of course, if you're taking your TS system to college or the office, TS Custom Cases are a lot less cumbersome than a bag or rucksack. And a lot more protective and professional.

**Designed by TS enthusiasts – for TS enthusiasts.**

Both the TS 1000 and 2000 Custom Cases were designed by a group of TS system users and manufactured by Britain's leading case makers. Made from impact-resistant ABS, each case holds every piece of Timex Sinclair hardware available for the respective computers – plus Learning Lab, manual, software cassettes and any cassette player up to 10 1/2" x 5 1/2". If you haven't all the hardware, simply leave the pre-cut foam in position, then remove it as you get extra pieces of equipment.

*And when brand new hardware is introduced, or you upgrade from 1000 to 2000, simply contact us for a replacement foam insert.*

**Send for your TS Custom Case – now!**

TS 1000 and 2000 Custom Cases are guaranteed for two years, and cost just \$79.95 (inc. postage) each. Remember you could pay more for an ordinary briefcase.

To order, simply use the coupon. Or telephone 0276 62155 (UK), weekdays.

## COMPUTEX CASES

Computex Cases (JBS), Stanhope Road, Camberley, Surrey, GU15 3PS, England.

Please allow 28 days for delivery. 14-day money-back undertaking.

**ZX81  
 Custom Case  
 also available!**



TIMEX SINCLAIR USER

To: Computex Cases (JBS), Stanhope Road, Camberley, Surrey, GU15 3PS, England.

Please send me \_\_\_\_\_ (qty) TS 1000 Custom Case(s) at \$79.95 (inc. airmail postage) each 01.

Please send me \_\_\_\_\_ (qty) TS 2000 Custom Case(s) at \$79.95 (inc. airmail postage) each 02.

Please debit my  Mastercard  Visa

account no. \_\_\_\_\_

Please tick box as applicable. PLEASE PRINT.

Signature \_\_\_\_\_

Name: Mr/Mrs/Ms \_\_\_\_\_

Street \_\_\_\_\_

City \_\_\_\_\_

State \_\_\_\_\_ Zip \_\_\_\_\_

Reg. in England no: 991288.

TSUS 305

For more information, circle 34 on reader service card.



Arguably the most famous personality in the world computer industry, Clive Sinclair remains something of an enigma. Bill Richardson profiles the man who helped pioneer the home computer — selling over a million Sinclair computers worldwide, and 600,000 more in the United States under the Timex name

## The Paradoxical World of Clive Sinclair

**N**OW 42, and with his company, Sinclair Research, recently valued at over 200 million dollars, Clive Sinclair can reflect on a 20-year career in electronics which has established him as Britain's leading high-technology entrepreneur.

He has many 'firsts' to his name, from the world's first pocket calculator (1972) and pocket television (1977), through to the first home computer under \$100 (1983). Ignoring those who believed that only experts were interested in computers, his aggressive marketing has taken Sinclair Research to the top.

He is both inventor and entrepreneur, points acknowledged recently by two major British awards.

First, the leading industry weekly *Computing* made him 'person of the decade', in recognition of a 10-years' radical and successful new product and development. Shortly after the *Guardian* newspaper made Clive its 'young businessman of the year' — and the latest in an august line which included Sir Michael Edwards, savior of the country's onetime ailing car giant, BL.

Yet his response was typically enigmatic. 'I'd have done anything to avoid this,' he joked at *Computing's* lunch presentation, and, speaking to the prestige audience

packing London's Mansion House, at the *Guardian* award ceremony, quipped, "I'm neither young nor a businessman."

"Uncle Clive" to the British man-in-the-street, he remains essentially shy, shunning personal publicity, except where it furthers his company or his products.

"Money," said this multi-millionaire in a recent interview, "is only a means to an end, not to make me wealthy but to produce useful products which I think people will enjoy."

He himself lives modestly — his company reflecting the same restrained and polished style. His 'highs' come, he says, "from doing for a dime what any fool can do for a dollar" — to translate a favorite English phrase.

Sinclair has no formal electronics training and opted not to go to university, preferring to learn on the job. He worked briefly as a journalist before setting up his own company in 1962.

Radio and amplifier kits were his first products with hi-fi systems added in the late 1960s. During these formative years he established the

principles which govern almost all Sinclair products — miniaturizing approach, low-cost for high performance, and a high-quality appearance.

His aggressive style has not always met with approval. Once in the late 1970s as Sinclair worked on digital watches, pocket televisions and industrial instruments, his concentration on research and development led the company into a troubled period.

Government financial aid and intervention, via Britain's National Enterprise Board (NEB), followed. Disagreeing with the NEB's cautious policy on consumer electronics, Sinclair moved out to establish a new company, Sinclair Research, and to vindicate himself entirely with the personal computer.

Beginning with the ZX80 and an initial staff of only seven, Sinclair Research has grown extremely rapidly. It grossed 130,000 sales with the ZX80, and now well over a million with the more advanced T/S1000, ZX81.

Measuring just 6" x 6½" x 1½", the ZX81 took miniaturization to its logical conclusion. Utilizing a four-chip design based on a Sinclair-designed ULA it maximizes high-performance for low-cost — currently just \$69 in the United States, — and presents a high-quality appearance, confirmed by the U.K.



# Profile

Design Council's 1982 award.

Behind this product lies an integrated design approach, stemming from a clearly defined business philosophy. Sinclair firmly believes in keeping his company small — even today there are only 55 direct employees — enabling complete cooperation between all departments.

That way he aims to avoid problems of large management superstructures and a bureaucracy which might stifle creativity, so vital to a fast-moving and increasingly competitive business. Sinclair sub-contracts all manufacture and most distribution.

Out of its major relationship with Timex grew the present agreement which, in return for a royalty on all sales, licenses Timex to use Sinclair's technology and name to

**"You set an objective — an office robot, say — and plot back from that the steps necessary to achieve it"**

manufacture and market personal computers, computer peripherals and software throughout North America.

Sinclair believed that Timex's manufacturing expertise with the ZX81, allied with its acknowledged marketing expertise in North America, where it has around 70,000 outlets, would prove a formidable combination — a belief well-proven by T/S1000 sales.

Interestingly, the agreement covers present and future developments at Sinclair together with Timex's own developments of the basic technology. There is no theoretical restriction on the potential of new computers.

Beyond the T/S1000, Timex expects to introduce later this year its version of Sinclair's Spectrum, dubbed the T/S2000. Spectrum, currently priced from about \$185 in the U.K., follows the usual innovative Sinclair pattern and with its powerful 16K ROM and maximum 48K RAM has opened a ma-

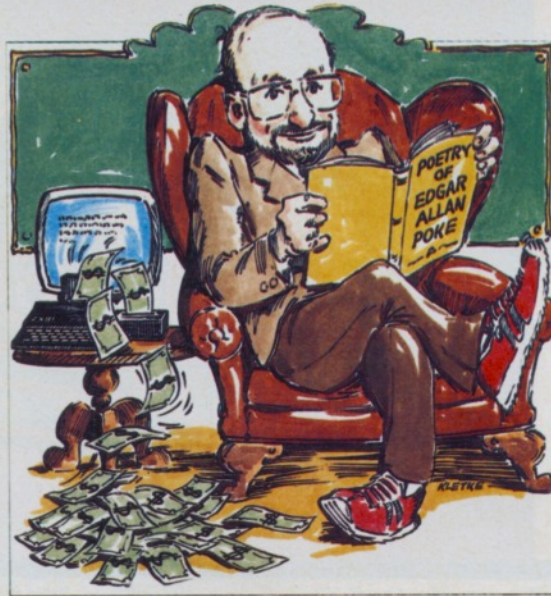

major new market. More than 200,000 have been sold in the U.K. alone.

The agreement exemplifies Sinclair's whole approach — sub-contract wherever appropriate, simple communication and flexibility. He abhors unnecessary fuss, producing a withdrawn yet aggressive business style which matches the personality and helps explain the enigma.

He believes his ideas illustrate a fundamental change now evolving in the West's economic structure. Increasingly he sees manufacturing employment declining — with work moving out to the Third World once products become traditional.

Then, he says, you start again — creating something new. By the 1990s, he hopes that Britain will

**Clive says he likes "to do for a dime what any fool can do for a dollar"**

have turned to the 'products of the mind' — books, video programs, computer software, design and consultancy services, health and education packages.

Sinclair Research, he is confident, has a major role to play in that kind of world. Later this year, it will launch a new 2" pocket television, incorporating advanced flat-screen technology. A color version will follow and there are tentative plans to incorporate an enlarged

screen into future computer developments.

Sinclair is currently exploring new ideas, many of them perhaps years from commercial exploitation, and his explanation of the process offers a fascinating insight.

"What one does, in fact, is to see a distant objective — an office robot, say — and to plot back from that all the steps that would need to be taken to achieve it. Having done that you might find that some of these steps couldn't be taken, so you would drop the idea for a while — or try to find solutions to those problems.

"Take for example the electric car that I propose to bring out in 1985. I've been toying with the idea of doing an electric vehicle for about 12 years, and done various little experimental vehicles to try

**Sinclair Research plans to introduce a pocket TV this year and an electric car in 1985 . . .**

out this idea or that. But it wasn't until two or three years ago that there had been enough innovation in all kinds of fields to give us a package that clicked."

One might imagine that the man's life is devoted solely to electronics but he has a wide range of outside interests, ranging from mathematics — interestingly, he prefers a slide rule to calculators or computers — to the theatre. Perhaps his greatest personal love is poetry.

He is also a trustee of the Cambridge Symphony Orchestra and chairman of the British Mensa Society — an organization which encourages intellectual contact among all walks of life.

Somewhere between the inventor and the entrepreneur, between the aggressive business style and quiet individual, between the electronics ideas and the cultural interests, lies the resolution of the Sinclair enigma — and the sparking point for a very successful man. ☺/☺



## These kids' books make learning fun

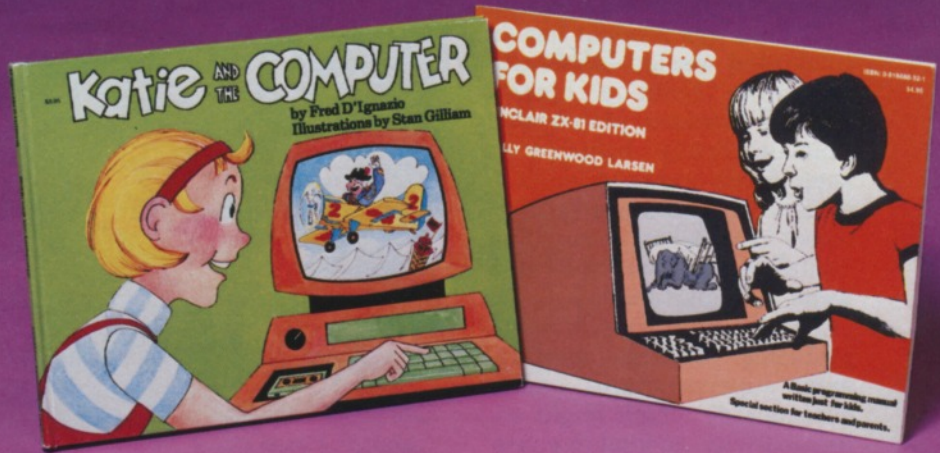

### *Computers for Kids and Katie and the Computer*

**T**HERE are many books on the market today aimed at teaching kids how to get the most from their home computers. Two of these are *Computers for Kids*, by Sally Greenwood Larsen, and *Katie and the Computer*, by Fred D'Ignazio. Both are from Creative Computing Press and both should delight young computer users everywhere.

*Katie* presents an *Alice in Wonderland*-type of story in which a young girl travels inside a home computer to see how it works. The machine is presented as a fantasy world of excitement and mystery; its various functions are personified as workers in a large metropolis. Through her computer travels, Katie witnesses first-hand how each function operates as she visits each worker on a quest to produce a picture of a flower on her monitor. She learns that each byte (worker) represents a specific number or letter and that the various functions (also workers) must work together in a precise order to produce the desired results.

There are no 'how-to's' in this book. It will not teach children who already have home computers how to use them. More of a bedtime story along the lines of a fairy tale, *Katie and the Computer* is useful for

introducing children to the idea of operating a home computer, for they will easily identify with Katie as she feels "happy, scared, and silly all at the same time." Like Katie, children may discover that using a home computer is "better than a roller coaster."

*Computers for Kids*, on the other hand, is a straightforward 'how-to' book that will guide home computer users of all ages through the various functions of the computer by practical application. Its step-by-step instructions allow hands-on application of principles that are outlined clearly and precisely. It is laid out attractively in lesson form with kids in mind: the lesson on flowcharting, for example, presents the problem, "How to Scare your Mom with an Elephant."

Unlike *Katie and the Computer*, which is a hardcover book with full color illustrations (by Stan Gilliam), *Computers for Kids* is a softcover edition with black and white il-

lustrations. But the illustrations are secondary to the text, which includes sections on flowcharting, programming, saving and loading, and explains terms used in Basic. *Computers for Kids* introduces children to the computer in a friendly, no-nonsense way, and encourages exploration and experimentation. It emphasizes that knowledge and know-how increases with practice, and encourages users to create and try out their own programs. A very helpful special section is aimed at helping parents and teachers, but the book is so easy to follow and the lessons so well explained that most kids should be able to follow it quite easily on their own. And once they've read the book and practiced the lesson assignments, they will have developed a sound understanding of their computer and will be ready to go on to a more in-depth study of computer language and technology. But of course they'll just think they're having fun.

To be useful as a learning guide, *Katie and the Computer* would unquestionably have to be used in conjunction with a book such as *Computers for Kids*. *Katie* inspires questions it does not answer. It will take its place on the shelf beside other children's stories, but *Computers for Kids* will be kept within reach of the computer, a useful guide and reference for the novice of any age.

— M. K. Wilson

A programming bug from Katie.

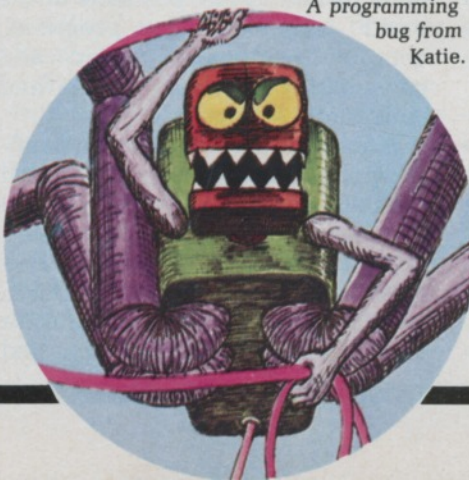



## All about ROMs



**I**N *Understanding Your ZX-81 ROM*, by Ian Logan, the reader doesn't have to contend with an update from the Sinclair ZX-80. Hold your joy, however, because since the book was published Sinclair has modified their original 8K ROM monitor. A two-page insert at the front of the book explains the differences, which are about a 3-byte offset from many of the figures given in the text. Of course, as time passes other ZX ROMs monitor versions will appear as these hidden trouble spots create problems and need to be eliminated.

The author logically assumes that the reader has a working knowledge of Timex/Sinclair Basic. He also writes for the person who knows the essential flow of a computer program. Following a quick review of the five basic I/O systems for the ZX81, the author gives an excellent overview on the function of the Z log Z80 CPU.

A brief introduction to machine coding is covered and contrasted with a like program segment in Basic. The author covers simple mathematics by explaining arithmetic in absolute binary and two's complement.

Armed with a two-page overview of hexadecimal coding (HEX), the author does an excellent job of tackling the Z80 machine code instruction set. The instruction set is conveniently divided into 18 major groups based on their functions. A definite plus to the book would have been a table in the back with instructions given in the 18 major groups.

The explanation of each group is given by referring to the 8K ROM for examples. By the time the reader has finished reading about all 18 groups, he should have gained excellent insight into the workings of the T/S1000 monitor and Basic interpreter.

However, don't try to cover all 18 groups in one reading. Dr. Ian

### *Understanding Your ZX-81 ROM*

Logan has put many hours into the preparation of his text and the reader will need considerable time to assimilate the information.

Logan gives the reader another chance if things get fuzzy on the first run-through on the 18 instruction code groups. Chapter Five demonstrates machine code programs for each group. Basic routines are also included to reveal the differences. These programs are short and require less than 1K of RAM. Finally, Chapter Six provides a good overview of the 8K ROM monitor program.

The reader is going to need several sessions with this book. But once he's gotten the information, he can dazzle his friends in a ZX81/Timex user group by writing a few machine code routines.

The book will also be an invaluable reference guide for someone using machine code routines. The publishers, Melbourne House, seem opposed to any sort of index. Such an index would have been a valuable addition.

— Warren Smith  
and Harry Petheram

## Fresh air from Reston

### *Making the Most of Your Timex Sinclair*

**I**F YOU'VE ever had to struggle through page after page of a boring book, you'll really appreciate this breath of fresh air: in fact, customs officials should have bestowed it a personality award. It's fun. The writing is very readable and will please both adult and child.

The book oozes personality. Part of that allure lies in its immigrant status: it was originally printed in England and brought to the United States by Reston. The American version is an intact duplicate of its British counterpart — Britishisms and all.

About 30 programs are stuffed into its pages. Each chapter includes a preamble, discussing particulars of each program, an explanation of how each's logic works, and a program listing. Programs include home applications for record keeping, a decision maker, an ESP test, a math quiz,

Lost In Space, UFO, and a sprinkling of light-hearted games.

Besides the programs which make up the main body of the book, there are a few other important features. The beginning of the book details the working nature of the graphics commands and random number strategies. These, by the way, are the two all-important keys to making a game interesting. Understanding them lends program design a clearer track.

The back of the book offers some useful subroutines — a compendium of short programs designed to make program writing less frustrating. Of these, the most valuable is the line renumbering utility. This program alone justifies my purchase of the book.

Hartnell's book was one of the first Timex/Sinclair books published in this country, and one of the top sellers. No wonder!

— Tim Banse



# Contents

"CLEVER CONTEST"

## WRITE AN UNUSUAL PROGRAM AND WIN \$20 10 WINNERS

**H**ERE it is — *Timex Sinclair User's* second programming competition. Write a program, any length, 1K to 16K, that does something unusual — not a game — not necessarily useful — just something unusual!

Maybe it produces the illusion of color on a black and white television; maybe it presents the most startling graphic we've ever seen; maybe — well, you do it and we'll judge it.

Make it

## **CLEVER, DIFFERENT, STRANGE & UNUSUAL**

and you could win \$20!

**F**ILL in the entry form at right and send it to us along with your program and a short explanation of what it does. (You may send a cassette, but please accompany it with a neatly-typed or beautifully hand-written listing.) Your entry must reach us by July 15, 1983. Please mark envelope, "Clever Contest." Judges' decisions final; employees of ECC Publications ineligible.

### **ENTRY FORM**

Send to:  
CLEVER CONTEST, c/o *Timex  
Sinclair User*, 49 LaSalle  
Avenue, Buffalo, N.Y. 14214

Name \_\_\_\_\_

Street \_\_\_\_\_

City \_\_\_\_\_ State \_\_\_\_\_ Zip \_\_\_\_\_

Program Title \_\_\_\_\_

Sorry, no submission can be returned.



Got some information you'd like to share regarding a new product or service or idea? Organizing an event you'd like to see listed? Let us know!

Write to Bulletin Board, Timex Sinclair User,  
49 La Salle Avenue, Buffalo, N.Y. 14214

**2-Bit Software** of Del Mar, California, has introduced a software four-pack that satirizes the suburban homemaker. *Mad Dash* test your ability to race through the house when you haven't had a break all day, while *Carfool* demands that you figure out how to use the least amount of gas while running errands all over town. *Harried Housewife* rewards you with a hot bath and nap after a hectic day that in-

## Software satirizes suburbanites

cludes a dazed search for your car in the parking lot of *Shopping Mall*. If you want to learn more, circle 63 on the reader service card and drop it in the mail . . . "We may have a keyboard for the T/S1000," **Pegasus Micro Systems** of Chestertown, Maryland, tells us, "that will allow you single stroke or at least you will only have to hit one shift key to get a command. This differs from the current keyboard where you have to hit five keys to get to the command you want." Pegasus comprises a group of programmers who have recently turned to marketing their own products; their winged-horse logo is distinctive. Their product list includes programs written in-house and by outside programmers; it is limited at the moment to a program of lists and an astromap, both of which need the 16K RAM pack.

They plan more software and hardware for the proposed T/S2000. For more information, circle 64 on reader service card . . . **Syntech** has brought out a motherboard known as *MicroMother* which will attach to the T/S1000 through a ribbon cable and will accommodate up to four circuit boards. The company has also developed a series of boards for use with the mother and known as *MicroDaughters*. They include a PROM programmer, an IBM keyboard driver modem and a real time clock. Further information can be obtained by circling 65 on the reader service card . . . **Orbyte Software** of Waterbury, Connecticut, is offering a software package that pits you against the computer in a four-tiered version of the old standard, *Tic Tac Toe*, a game that prehistoric men must have played on the walls of their caves. *Expo Tic-Tac-Toe* can be played at four levels of difficulty from beginner to impossible. For more information, circle 66 on reader service card . . . In their newsletter of March 1983, the *Sinclair Users' Network* of Palatine, Illinois, recommends the *E-Z Key 60* keyboard by **E-Z Key**. Quotable quotes: "Now . . . we all can benefit from depressable keys without knowing what a good solder joint looks like . . . The keys feel good and provide excellent tactile and audible feedback . . . It has been found to be easy to connect, trouble-free, and a great aid in the entry of keywords and data . . ." For

more information on the *E-Z Key 60*, circle 67 on the reader service card and watch our Hardware pages . . .

**ZX-Panding Ltd.** of Newton, N.C., has introduced what it claims is the first complete data storage program with graphing capabilities for the T/S1000/ZX81. Their *Data Storage and Display System* (\$14.75) "allows you to closely monitor stock market, experimental or any numerical data . . . These values can be stored in up to 25 files in the computer and then recalled as a tabular list or graph accompanied by a data summary." For more information, circle 68 on reader service card . . . **E. Arthur Brown Company** of Alexandria, Maine, has published the

*Timex-Sinclair 1983 Directory*, a 90-page softcover book that lists, describes and provides photographs of available peripherals and software for the T/S1000/ZX81. The book, which will sell for \$5, is subtitled, "Where to Find Practically Everything for the Timex-Sinclair Computer," and includes an up-to-the-minute directory of suppliers. For more information, circle 69 on the reader service card and watch our book pages . . . If you've got a new product or service or idea that you'd like to share with our readers, write to **Bulletin Board**, Timex Sinclair User, 49 La Salle Avenue, Buffalo, N.Y. 14214. Remember, this page is for you! ☺☺☺

## Upcoming events

June 1-3	International Communications Assoc. Conference and Exposition, Anaheim, CA	Expo, Washington, DC
		14-18 Micro Expo, Paris, France
1-3	Montreal Computer Show & Conference, Montreal, Que.	16-19 Milwaukee Computer Showcase, Milwaukee, WI
5-8	International Summer Consumer Electronics Show, Chicago, IL	19-22 International Conference on Communications, Boston, MA
9-12	Kansas City Computer Showcase Expo, Kansas City, MO	22-4 Computerama '83, Toronto, Ont.
12-17	American Society for Medical Technology Meeting & Exhibit, Los Angeles, CA	27-29 Videotext '83, New York, NY
14-16	AFCEA Convention and	29-7/1 Dexpo/Europe, London, Eng.
		July 11-13 Meeting World, New York, NY
		25-29 Siggraph '83, Detroit, MI
		29-31 Los Angeles/Produx 2000, Los Angeles, CA



# Use this free info service

To obtain more information on any advertiser or product in *Timex Sinclair User*, circle the appropriate number on the reader service card.

Page	Advertiser	Circle Number
54	Brainchild	21
13	Byte Back	6
72	Cascade	35
11	Computer Entrepreneur	7
65	Computex Cases	34
72	Cover Craft	36
48-49	DK'Tronics	19
45	Eagle Sales Co.	16
62	E. Arthur Brown	
64	Electronics & Computing	33
62	Electronic Tech. Today	30
26	Expense Cutter	10
41	E-Z Key	9
31	Felix Software	15
8	Filesixty	40
20-21	Gladstone Electronics	8
C2	Gladstone Electronics	37
54	Hunter	20
6	Innovation	3
55	Intercomputer	23
18	Int'l. Pub. & Software	5
24	Int'l. Pub. & Software	17
26	Kempston	11
26	KSOFT	12
62	Laserscan	26
C4	Leading Edge	39
10	Melbourne House	4
C3	Memotech	38
26	Microdevelopments	13
64	Microsystems Development	32
54	Notting Dale Tech. Ctr.	22
57-60	Prism Microproducts	24
62	Run-It	25
31	Sinclair Place	14
64	Synchro-Sette	31
4-5	Syntax	2
1	Timex	1
62	Tom Woods	28
62	York 10	27
32	Zebra	18

## DON'T MISS THIS INCREDIBLE OFFER!

# 50 GAMES

**\$19.95** on cassette for all the following:  
**TIMEX**  
**sinclair**  
**ZX81**  
**TI 1000**  
**SPECTRUM**  
**TI 2000**

**YES, 50 GAMES!**

FOR YOUR MICRO-COMPUTER

GALACTIC ATTACK  
 SPACE MISSION  
 LUNAR LANDER  
 PLASMA BOLT  
 STARTREK  
 RADAR LANDING  
 ATTACKER  
 GALACTIC DOGFIGHT  
 ZION ATTACK  
 IVASHIVE ACTION  
 OXO  
 BOGGLES  
 PONTON  
 SKI JUMP  
 HANGMAN  
 OLD BONES  
 THIN ICE

MAZE EATER  
 ORBITTER  
 MOTORWAY  
 FORCE FIELD  
 NIM  
 TUNNEL ESCAPE  
 BARREL JUMP  
 CANNONBALL BATTLE  
 OVERTAKE  
 SITTING TARGET  
 SMASH THE WINDOWS  
 SPACE SHIP  
 JET FLIGHT  
 PHASER  
 INTRUDER  
 INFERNO  
 GHOSTS

SUBMARINES  
 ROCKET LAUNCH  
 PLANETS  
 BLACK HOLE  
 DYNAMITE  
 DO YOUR SUMS  
 DERBY DASH  
 SPACE SEARCH  
 UNIVERSE  
 RATS  
 TANKER  
 PARACHUTE  
 JETMOBILE  
 HIGH RISE  
 THE FORCE  
 EXCHANGE

Also available for  
**ATARI 400/800**  
**VIC-20**

apple (ON DISC & CASSETTE)



Mail order direct to: —  
**CASCADE SOFTWARE** 37 Fruehauf Street  
 Buffalo, N.Y. 14226

MINIMUM SIZE COMPUTER REQUIRED ONLY

SUPPLY CASSETTE 50 FOR \_\_\_\_\_ COMPUTER

I enclose a cheque/P.O. \_\_\_\_\_

Name \_\_\_\_\_

Address \_\_\_\_\_

Zip Code \_\_\_\_\_

**ORDER NOW!**

For more information, circle 35 on Reader Service Card.

# Take it with you!

Fieldpro™ now makes it easy for you to carry your entire Timex/Sinclair computer system with you. Carry memory modules, cables, program book and cassette tapes in one case!

Made of waterproof DuPont® Cordura® nylon — fully foam-padded and soft-lined, this case will last for years.

Contact us for the dealer nearest you. Only \$19.95. (If ordering

direct, include \$2.25 shipping charge.)

Also available, anti-static dust cover for \$6.95. Order with case and save extra shipping charge.

**Fieldpro**  
 BY COVER CRAFT

P.O. Box 555, Amherst, New Hampshire 03031 • Telephone 603-889-6811

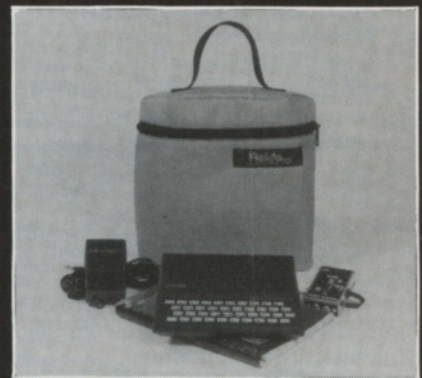



# TIMEX MAKES THE COMPUTER, BUT WE MAKE IT TICK.

If you own a TS-1000 or ZX-81 computer and want to bring out the power within it, you'll want Memotech. From easier input to high quality output and greater memory, Memotech makes the add-ons you demand. Every Memotech peripheral comes in a black anodized aluminum case and is designed to fit together in "piggy back" fashion enabling you to continue to add on and still keep an integrated system look.

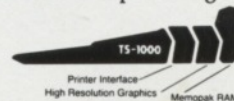

**MEMOPAK RAM** All Memopak RAMs are directly addressable, user transparent, are neither switched nor paged and no additional power supply is required. You can also choose the Memopak RAM which is just right for your needs. From economy to power. **16K RAM** The Memopak 16K RAM is the most economical way to add memory to your TS-1000. It is fully compatible with the Timex or Memotech 16K RAMs to provide you with up to 32K of RAM. The 16K RAM also offers additional add-on capabilities through its "piggy back" connection. **32K RAM** The 32K Memopak enables you to execute sophisticated programs and store large data bases and like the 16K RAM is fully compatible with Timex's or Memotech's 16K RAMs to give you a full 48K of RAM. **64K RAM** The 64K Memopak is powerful enough to turn your TS-1000 into a computer with capabilities suitable for business and educational use. It accepts such BASIC commands as 10 DIM A (9000). **MEMOCALC** Memocalc, our spreadsheet analysis

software, enables TS-1000 users to perform complex number crunching routines with ease. With the 64K RAM a table of up to 7000 numbers with up to 250 rows or 99 columns can be specified. Quick revisions can be achieved by entering new data to your formula.

**MEMOTECH KEYBOARD** For ease of operation, the Memotech keyboard is a high quality standard typewriter keyboard, with TS-1000 legends. The keyboard is cable connected to a buffered interface which is housed in a standard Memopak case and plugs directly into the back of the



TS-1000 or other Memopaks. **MEMOPAK HRG** The Memopak High Resolution Graphics, with up to 192 by 248 pixel resolution, enables display of high resolution "arcade game" style graphics through its resident 2K EPROM, programmed with a full range of graphics subroutines.

### CENTRONICS PARALLEL AND RS232 INTERFACES

Memotech's Interfaces enable your TS-1000 to use a wide range of compatible printers. The resident software in the units gives the

complete ASCII set of characters. Both Memopak Interfaces provide lower case character capabilities and up to 80 column printing. The RS232 Interface is also compatible with modems and terminals.

**SEIKOSHA GP 100A PRINTER** The Seikosha GP 100A uses a 5x7 dot matrix printing format with ASCII standard upper and lower case character set. Printing speed is 30 characters/second with a maximum width of 80 characters. The printer uses standard fanfold paper up to 9-1/2 inches wide. The GP 100A is offered as a package including cable and interface. Other printer packages are also available through Memotech.

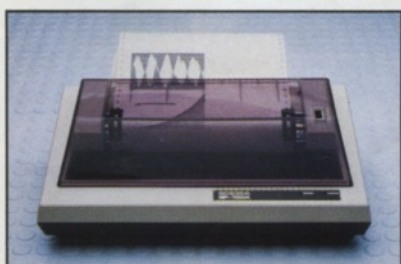
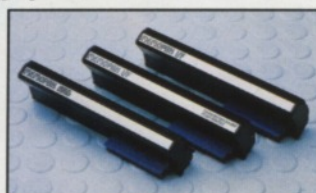

**ORDER AT NO RISK.** All Memotech products carry our 10 day money back guarantee. If you're not completely satisfied, return it within ten days and we will give you a full refund. And every Memotech product comes with a six month warranty. Should anything be

defective with your Memotech product, return it to us and we will repair or replace it free of charge. Dealer inquiries welcome. To order any Memotech product use the order coupon or call our toll-free number **800/662-0949.**

TS-1000 is a registered trademark of Timex Corp.

**MEMOTECH**  
CORPORATION

7550 West Yale Avenue, Denver, Colorado 80227, 303/986-1516, TWX 910-320-2917

Mail To: Memotech Corporation, 7550 West Yale Ave., Denver, CO 80227			
Code:	Price*	Qty.	Total
16K RAM	\$ 49.95		
32K RAM	99.95		
64K RAM	149.95		
Memocalc	49.95		
Keyboard with Interface	99.95		
High Resolution Graphics	99.95		
Centronics Parallel Interface	74.95		
RS232 Interface	99.95		
Printer Cable	19.95		
GP 100A Printer Package**	399.00		
Shipping and Handling	4.95		\$ 4.95
Tax (Colorado residents only)			
TOTAL			\$
*All prices quoted in U.S. dollars. Prices and specifications subject to change without notice.			
**Please add an additional \$5.00 for printer shipping charges.			
<input type="checkbox"/> Check <input type="checkbox"/> MasterCard <input type="checkbox"/> Visa			
Account No.	Exp.		
Name	Phone number		
Address			
City	State	Zip	



# TRUNKS FOR THE MEMORIES.



Introducing the most logical place to store Elephant Memory Systems® (or lesser brands of disks): The Trunk.

With its alphabetized library index, you can file or retrieve up to 60 disks, instantly.

The Trunk is made of durable molded plastic with a hinged, one-piece lid, to keep disks safe from dust, dirt, and other detriments which disks despise.

And, it's portable. Because the lid doubles as a carrying handle so your Elephant Memory Systems® disks can go anywhere you do.

There's a model for 5¼" and 8" floppies, as well as a cassette-and-game file and a special Atari® version.

So if you're looking for the best disk storage system on the market . . .

The Trunk is an open-and-shut case.

## THE TRUNK. ENDORSED BY ELEPHANTS.

### Elephant Memory Systems® Disks

*A full line of top-quality floppies, in virtually every 5¼" and 8" model, for compatibility with virtually every computer on the market. Guaranteed to meet or exceed every industry standard, certified 100% error-free and problem-free, and to maintain its quality for at least 12 million passes (or over a life-time of heavy-duty use).*

Marketed exclusively by Leading Edge Products, Inc., 225 Timpike Street, Canton, Massachusetts 02021.  
Call: toll-free 1-800-343-6833; or in Massachusetts call collect (617) 828-8150. Telex 951-624.

For more information, circle 39 on reader service card.